

# Cardale Garage Door Range

Price List and Technical Information

January 2020 v2



# Contents

	Page Nos
Steel up & over doors	4-11
Golden Oak and Rosewood up & over doors	12-17
Steel Secured by Design doors	18-19
Steel Side Hinged doors	20-21
Steel Side Hinged Golden Oak and Rosewood	22-23
Steel Personnel doors	24-25
Timber up & over doors	26-36
Timber Secured by Design doors	37
Timber Side Hinged doors	38-40
GRP up & over doors	41-43
GRP Side Hinged and Personnel doors	44
Steeline roller doors	45
Sectional doors	46-50
ABS doors	51
Insulated aluminium roller doors	52
Technical door information	53-69
Warranty, Terms and Conditions	70

## General information

### Information for all doors

All products are sold subject to our standard conditions of sale, which are available on request and include the following:

#### Prices

All orders are accepted on the understanding that the goods will be subject to the prices ruling at the time of delivery, unless other terms are specifically agreed. All prices are in £ sterling and exclude carriage and VAT.

#### Panel Configurations

The proportions of the door's panel configurations may vary according to the actual size specified.

#### Lock Handle Position

Lock handle position varies according to the design and the lifting gear type. Lock holes are supplied as standard on up & over, side hinged and Steeline Roller doors unless specified at the time of order.

### Timber doors

The Company accepts no liability for natural variations in colour, warping, swelling or shrinkage due to ordinary natural processes of ageing, fading or the effects of weather or climate or shrinkage, warping or swelling which could have been prevented by carrying out finishing and maintenance as recommended by the Company.

All doors in the Futura and Heritage ranges are supplied with a two coat factory base coat stain treatment. These doors should be finished with a micro-porous stain, front and back, in accordance with the stain manufacturer's instructions immediately after fitting.

### Made to measure doors

Doors can be ordered in 1/2" increments.

#### Door diagrams

Single door diagrams shown depict 7'0" x 7'0" doors.  
Double door diagrams shown depict 14'0" x 7'0" doors

#### Specification

The Company reserves the right to make any alterations in design or manufacture without notification as is deemed necessary to ensure continual product development.

Prior to fitting they must not be stored in direct sunlight or exposed to splashes or rain as colour fading and staining may occur respectively.

Fully finished timber doors should be re-stained approximately every four years, regular inspections should be carried out and this period reduced as necessary.

Please note that timber is a beautiful material with naturally occurring colour and grain variations. Please tell us if you require matching pairs as we will do our best to match both doors.

### GRP doors

GRP by definition, is manufactured from translucent strands of glass. This characteristic may occasionally show itself in translucency of the panel under bright external conditions when viewed from inside with the door closed, but this does not represent a defect in the construction or strength of the door.

Please note that our GRP doors are handcrafted. This may result in shade variations. Please tell us if you require doors to match and we will do our best to achieve as close a door match as possible.

### Side hinged doors and Personnel doors

All doors will be supplied with locking and lock holes unless specified otherwise on order.

### Thermaglide roller doors

Due to manufacturing processes the bottom lath and guides may vary in colour from the rest of the door. Your door will be Made to

Measure to suit the dimensions given.

### ABS doors

AWAITING NEW TEXT PAUL MURPHY

AWAITING NEW TEXT HERE.

### Bespoke made to order doors

Steel door prices in bold shown on pages 4, 5 & 6 are stock doors on a standard lead time in white. All other sizes are made to measure.

The designs & sizes detailed in this brochure are an indication of price for the design & size required. Your right to cancel is not available on non-standard made to order doors.

### Delivery charges, all doors

#### Product appearance

Garage doors should be inspected upon delivery and viewed in natural daylight (not direct sunlight) from a standard distance of 3 metres to view their overall appearance. From this distance the door panel should appear free from visible marks or distortion, stains, blemishes, indentations or scuffs.

#### Storage

Garage doors should be stored in their original packaging standing upright on flat ground. Avoid placing on stony or uneven surfaces. Doors should always be lifted and not dragged into place. Do not rest doors against each other without first placing protective packaging in between. Install as soon as possible once the goods have arrived on site.

# STEEL SINGLE UP & OVER DOORS

## Cardale powder coated pre-finished single steel doors

**Standard size  
single doors  
Pre-finished white**

Size mm (ft/in)  
Width by Height

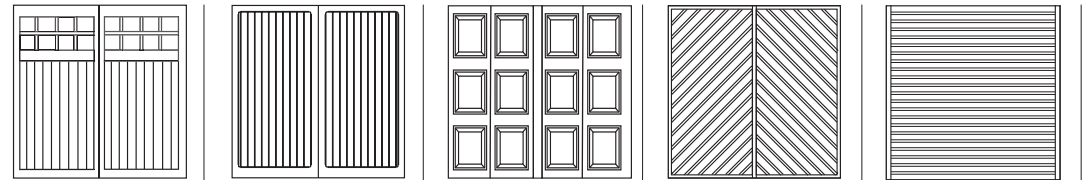

Size mm (ft/in) Width by Height	Bedford		Berkeley Vertical		Brompton		Chevron		Europa II	
	C	R	C	R	C	R	C	R	C	R
1981 x 1981 (6'6" x 6'6")	-	-	1020	1084	885	948	-	-	615	679
1981 x 2134 (6'6" x 7'0")	-	-	1020	1084	885	948	-	-	615	679
2083 x 1905 (6'10" x 6'3")	-	-	1020	1084	885	948	-	-	615	679
2083 x 1930 (6'10" x 6'4")	-	-	1020	1084	885	948	-	-	615	679
2083 x 1956 (6'10" x 6'5")	-	-	1020	1084	885	948	-	-	615	679
2083 x 1981 (6'10" x 6'6")	-	-	1020	1084	885	948	-	-	615	679
2108 x 1981 (6'11" x 6'6")	1220	1284	1020	1084	885	948	-	-	615	679
2108 x 2134 (6'11" x 7'0")	1220	1284	1020	1084	885	948	-	-	615	679
2134 x 1828 (7'0" x 6'0")	1220	1284	1020	1084	-	-	-	-	615	679
2134 x 1880 (7'0" x 6'2")	1220	1284	1020	1084	885	948	-	-	615	679
2134 x 1905 (7'0" x 6'3")	1220	1284	1020	1084	885	948	-	-	615	679
2134 x 1930 (7'0" x 6'4")	1220	1284	1020	1084	885	948	-	-	615	679
2134 x 1981 (7'0" x 6'6")	1220	1284	1020	1084	885	948	717	782	615	679
2134 x 2134 (7'0" x 7'0")	1226	1290	1071	1135	934	1000	783	847	667	730
2210 x 1930 (7'3" x 6'4")	1265	1329	1071	1135	1000	1064	-	-	702	766
2261 x 1981 (7'5" x 6'6")	1265	1329	1071	1135	1000	1064	-	-	702	766
2261 x 2134 (7'5" x 7'0")	1265	1329	1071	1135	1000	1064	-	-	702	766
2286 x 1828 (7'6" x 6'0")	1265	1329	1071	1135	1000	1064	-	-	702	766
2286 x 1905 (7'6" x 6'3")	1265	1329	1071	1135	1000	1064	-	-	702	766
2286 x 1981 (7'6" x 6'6")	1265	1329	1071	1135	1000	1064	911	847	702	766
2286 x 2134 (7'6" x 7'0")	1269	1333	1071	1135	1169	1232	859	923	803	867
2438 x 1905 (8'0" x 6'3")	1338	1402	1183	1246	1194	1259	-	-	810	874
2438 x 1930 (8'0" x 6'4")	1338	1402	1183	1246	1194	1259	-	-	810	874
2438 x 1981 (8'0" x 6'6")	1338	1402	1183	1246	1194	1259	-	-	810	874
2438 x 2134 (8'0" x 7'0")	1342	1406	1183	1246	1276	1338	-	-	826	891
2743 x 1981 (9'0" x 6'6")	-	-	-	1305	-	1457	-	-	-	-
2743 x 2134 (9'0" x 7'0")	-	-	-	1305	-	1457	-	-	-	-
2896 x 1981 (9'6" x 6'6")	-	-	-	1439	-	1586	-	-	-	-
2896 x 2134 (9'6" x 7'0")	-	-	-	1439	-	1586	-	-	-	-
3048 x 1981 (10'0" x 6'6")	-	-	-	1479	-	1712	-	-	-	-
3048 x 2134 (10'0" x 7'0")	-	-	-	1479	-	1712	-	-	-	-

C = Canopy gear, R = Retractable gear

**Made to Measure doors add £174**

**Size availability (mm) for Made to Measure doors**

Minimum width	2083	2083	1981	1981	1981	1981	1981	1981	1981	1981
Maximum width	2438	2438	2438	3048	2438	3048	2438	2438	2438	3048
Minimum height	1829	1860	1829	1860	1868	1868	1829	1860	1829	1860
Maximum height	2134	2286	2134	2286	2184	2184	2134	2286	2134	2286

**For Steel Up & Over Door options see page 7**

## Cardale powder coated pre-finished single steel doors

### Standard size single doors Pre-finished white

Size mm (ft/in)  
Width by Height

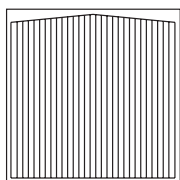

**Gatcombe**

C R

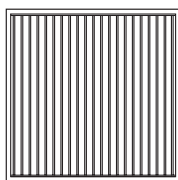

**Gemini**

C R

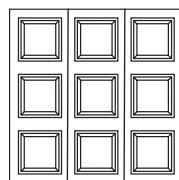

**Georgian**

C R

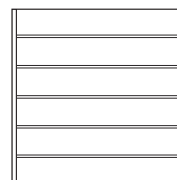

**Haven**

C R

Size mm (ft/in)	Width	Height	Gatcombe C	Gatcombe R	Gemini C	Gemini R	Georgian C	Georgian R	Haven C	Haven R
1981 x 1981 (6'6" x 6'6")	1020	1084	717	782	885	948	732	795		
1981 x 2134 (6'6" x 7'0")	1020	1084	717	782	885	948	732	795		
2083 x 1905 (6'10" x 6'3")	1020	1084	717	782	-	-	-	-		
2083 x 1930 (6'10" x 6'4")	1020	1084	717	782	885	948	732	795		
2083 x 1956 (6'10" x 6'5")	1020	1084	717	782	885	948	732	795		
2083 x 1981 (6'10" x 6'6")	1020	1084	717	782	885	948	732	795		
2108 x 1981 (6'11" x 6'6")	1020	1084	717	782	885	948	732	795		
2108 x 2134 (6'11" x 7'0")	1020	1084	717	782	885	948	732	795		
2134 x 1828 (7'0" x 6'0")	1020	1084	717	782	-	-	732	795		
2134 x 1880 (7'0" x 6'2")	1020	1084	717	782	-	-	732	795		
2134 x 1905 (7'0" x 6'3")	1020	1084	717	782	-	-	732	795		
2134 x 1930 (7'0" x 6'4")	1020	1084	717	782	885	948	732	795		
2134 x 1981 (7'0" x 6'6")	1020	1084	717	782	885	948	732	795		
2134 x 2134 (7'0" x 7'0")	1071	1135	783	847	1000	1064	839	903		
2210 x 1930 (7'3" x 6'4")	1071	1135	783	847	1000	1064	839	903		
2261 x 1981 (7'5" x 6'6")	1071	1135	783	847	1000	1064	839	903		
2261 x 2134 (7'5" x 7'0")	1071	1135	783	847	-	-	839	903		
2286 x 1828 (7'6" x 6'0")	1071	1135	783	847	-	-	839	903		
2286 x 1905 (7'6" x 6'3")	1071	1135	783	847	1000	1064	839	903		
2286 x 1981 (7'6" x 6'6")	1071	1135	859	923	1169	1232	938	1002		
2286 x 2134 (7'6" x 7'0")	1183	1247	922	986	-	-	995	1058		
2438 x 1905 (8'0" x 6'3")	1183	1247	922	986	1213	1276	995	1058		
2438 x 1930 (8'0" x 6'4")	1183	1247	922	986	1213	1276	995	1058		
2438 x 1981 (8'0" x 6'6")	1183	1247	961	1025	1213	1276	1033	1098		
2438 x 2134 (8'0" x 7'0")	1183	1247	961	1025	1213	1276	1033	1098		
2743 x 1981 (9'0" x 6'6")	-	-	-	1213	-	1527	-	-		
2743 x 2134 (9'0" x 7'0")	-	-	-	1338	-	1752	-	-		
2896 x 1981 (9'6" x 6'6")	-	-	-	1338	-	1752	-	-		
2896 x 2134 (9'6" x 7'0")	-	-	-	1449	-	1829	-	-		
3048 x 1981 (10'0" x 6'6")	-	-	-	1449	-	1829	-	-		
3048 x 2134 (10'0" x 7'0")	-	-	-	1421	-	1793	-	-		

C = Canopy gear, R = Retractable gear

### Made to Measure doors add £174

#### Size availability (mm) for Made to Measure doors

Minimum width	1981	1981	1981	1981	1981	1981	1981	1981
Maximum width	2438	2438	2438	3048	2438	3048	2438	2438
Minimum height	1829	1860	1829	1860	1914	1914	1860	1880
Maximum height	2134	2286	2134	2286	2158	2158	2134	2286

For Steel Up & Over Door options see page 7

# STEEL SINGLE UP & OVER DOORS

## Cardale powder coated pre-finished single steel doors

**Standard size  
single doors  
Pre-finished white**

Size mm (ft/in)  
Width by Height

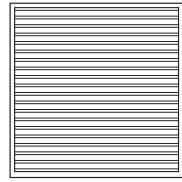

**Orion Horizontal**

C

R

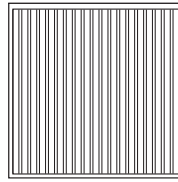

**Orion Vertical**

C

R

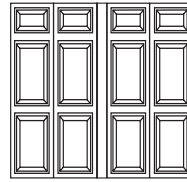

**Sheraton II**

C

R

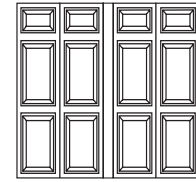

**Sheraton II glazed**

C

R

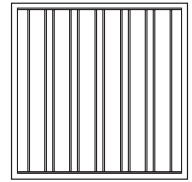

**Vogue**

C

R

Size mm (ft/in)	Width	Height	Orion Horizontal C	Orion Horizontal R	Orion Vertical C	Orion Vertical R	Sheraton II C	Sheraton II R	Sheraton II glazed C	Sheraton II glazed R	Vogue C	Vogue R
1981 x 1981	[6'6" x 6'6"]		885	948	938	1002	885	948	1237	1301	857	921
1981 x 2134	[6'6" x 7'0"]		885	948	938	1002	885	948	1237	1301	857	921
2083 x 1905	[6'10" x 6'3"]		885	948	938	1002	885	948	1237	1301	857	921
2083 x 1930	[6'10" x 6'4"]		885	948	938	1002	885	948	1237	1301	857	921
2083 x 1956	[6'10" x 6'5"]		885	948	938	1002	885	948	1237	1301	857	921
2083 x 1981	[6'10" x 6'6"]		885	948	938	1002	885	948	1237	1301	857	921
2108 x 1981	[6'11" x 6'6"]		885	948	938	1002	885	948	1237	1301	857	921
2108 x 2134	[6'11" x 7'0"]		885	948	938	1002	885	948	1237	1301	857	921
2134 x 1828	[7'0" x 6'0"]		885	948	938	1002	-	-	-	-	857	921
2134 x 1880	[7'0" x 6'2"]		885	948	938	1002	885	948	1237	1301	857	921
2134 x 1905	[7'0" x 6'3"]		885	948	938	1002	885	948	1237	1301	857	921
2134 x 1930	[7'0" x 6'4"]		885	948	938	1002	885	948	1237	1301	857	921
2134 x 1981	[7'0" x 6'6"]		885	948	938	1002	885	948	1237	1301	857	921
2134 x 2134	[7'0" x 7'0"]		934	999	990	1054	934	999	1287	1351	882	946
2210 x 1930	[7'3" x 6'4"]		1000	1064	1058	1122	1000	1064	1350	1414	990	1054
2261 x 1981	[7'5" x 6'6"]		1000	1064	1058	1122	1000	1064	1350	1414	990	1054
2261 x 2134	[7'5" x 7'0"]		1000	1064	1058	1122	1000	1064	1350	1414	990	1054
2286 x 1828	[7'6" x 6'0"]		1000	1064	1058	1122	-	-	-	-	990	1054
2286 x 1905	[7'6" x 6'3"]		1000	1064	1058	1122	1000	1064	1350	1414	990	1054
2286 x 1981	[7'6" x 6'6"]		1000	1064	1058	1122	1000	1064	1350	1414	990	1054
2286 x 2134	[7'6" x 7'0"]		1169	1232	1238	1302	1169	1232	1521	1586	990	1054
2438 x 1905	[8'0" x 6'3"]		1194	1259	1267	1331	1213	1276	1566	1629	1055	1119
2438 x 1930	[8'0" x 6'4"]		1194	1259	1267	1331	1213	1276	1565	1629	1055	1119
2438 x 1981	[8'0" x 6'6"]		1194	1259	1267	1331	1213	1276	1565	1629	1055	1119
2438 x 2134	[8'0" x 7'0"]		1276	1338	1351	1417	1213	1276	1565	1629	1092	1158
2743 x 1981	[9'0" x 6'6"]		-	-	-	1581	-	1305	-	2039	-	1546
2743 x 2134	[9'0" x 7'0"]		-	-	-	1581	-	1305	-	2039	-	1546
2896 x 1981	[9'6" x 6'6"]		-	-	-	1808	-	1840	-	2264	-	1611
2896 x 2134	[9'6" x 7'0"]		-	-	-	1808	-	1840	-	2264	-	1611
3048 x 1981	[10'0" x 6'6"]		-	-	-	1885	-	1368	-	2341	-	1675
3048 x 2134	[10'0" x 7'0"]		-	-	-	1885	-	1368	-	2341	-	1675

C = Canopy gear, R = Retractable gear

**Made to Measure doors add £174**

**Size availability (mm) for Made to Measure doors**

	1981	1981	1981	1981	1981	1981	1981	1981	1981	1981
Minimum width	1981	1981	1981	1981	1981	1981	1981	1981	1981	1981
Maximum width	2438	2438	2438	2438	2438	3048	2438	3048	2438	3048
Minimum height	1829	1860	1829	1860	1868	1868	1868	1868	1829	1860
Maximum height	2134	2286	2134	2286	2184	2184	2184	2184	2134	2286

**For Steel Up & Over Door options see page 7**

## STEEL SINGLE UP & OVER DOORS - OPTIONS

### Cardale powder coated pre-finished steel single doors - OPTIONS

#### Steel up & over single door options

Standard frame	add £133
Coloured frame	add £182
Cardale DC650T operator	add £511
Cardale DC800T operator	add £663
standard Glazing (Bedford)	add £160 (Stippled) Black mock glazing
standard Glazing (Brompton)	add £338
Glazing (Georgian)	add £338
Painted door	add £84 (White)

#### Steel doors including windows.

The standard colour window frame for white doors is white. For non-white coloured doors and for Rosewood and Golden Oak laminated doors the window frame colour will be black. Colour matched window frames are available but must be specified at time of order.

Colour matched window frames (except Bedford) add £35 per window

Colour matched window frames for Bedford add £140 per door

Prices applicable to all available heights (made to measure doors only).

#### Optional extras for operators

Extra handsets	add £77 (2 channel) add £85 (4 channel)
Wireless key pad	add £211
External manual override	add £48
Keyswitch	add £51

Frames ordered with a double door will be supplied as a separate knocked down item.

**All steel up & over doors are bespoke and made to order.**

#### Colours available for steel doors:

RAL 7038	Ageta Grey
RAL 7016	Anthracite Grey
RAL 6005	Balmoral Green
RAL 8017	Conker Brown
RAL 9011	Graphite Black
RAL 9004	Signal Black
RAL 9005	Ebony Black
RAL 7035	Light Grey
RAL 5013	Oxford Blue
RAL 5011	Midnight Blue
RAL 3003	Monarch Red
RAL 3009	Oxide Red
RAL 8003	Signal Brown
RAL 7004	Signal Grey
RAL 5024	Pastel Blue
RAL 6009	Fir Green
RAL 6013	Reed Green
BS4800-14C35	Chartwell Green
BS4800-12B17	Willow Green
BS381-420	Dark Camouflage Desert Sand
BS381-389	Camouflage Beige
RAL 9001	Cream
Cherry - Master Chroma 3353	

Cardale doors are supplied white RAL 9016 as standard.

# STEEL DOUBLE UP & OVER DOORS

## Cardale powder coated pre-finished double steel doors

### Standard size double doors Pre-finished white

Size mm (ft/in)  
Width by Height

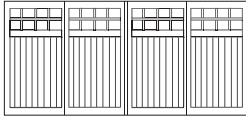
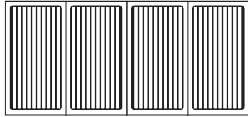
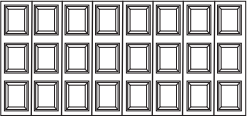
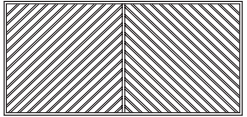
	 <b>Bedford*</b>	 <b>Berkeley Vertical</b>	 <b>Brompton</b>	 <b>Chevron</b>
	R	R	R	R
3200 x 1981 (10'6" x 6'6")	1827	1461	1739	-
3200 x 2134 (10'6" x 7'0")	1827	1461	1739	-
3353 x 1981 (11'0" x 6'6")	1886	1510	1795	-
3353 x 2134 (11'0" x 7'0")	1886	1510	1795	-
3505 x 1981 (11'6" x 6'6")	1943	1555	1851	-
3505 x 2134 (11'6" x 7'0")	1943	1555	1851	-
3658 x 1981 (12'0" x 6'6")	2002	1602	1906	-
3658 x 2134 (12'0" x 7'0")	2002	1602	1906	-
3810 x 1981 (12'6" x 6'6")	2061	1649	1962	-
3810 x 2134 (12'6" x 7'0")	2061	1649	1962	-
3962 x 1981 (13'0" x 6'6")	-	1933	2122	-
3962 x 2134 (13'0" x 7'0")	-	1933	2147	-
4115 x 1981 (13'6" x 6'6")	-	1933	2122	-
4115 x 2134 (13'6" x 7'0")	-	1933	2147	-
4267 x 1981 (14'0" x 6'6")	2415	1933	1878	2528
4267 x 2134 (14'0" x 7'0")	2415	1933	1878	2528
4420 x 1981 (14'6" x 6'6")	2536	2269	2039	-
4420 x 2134 (14'6" x 7'0")	2536	2269	2039	-
4572 x 1981 (15'0" x 6'6")	2658	2328	2275	-
4572 x 2134 (15'0" x 7'0")	2658	2328	2305	-
4877 x 1981 (16'0" x 6'6")	2899	2421	2630	-
4877 x 2134 (16'0" x 7'0")	2899	2421	2660	-

R = Retractable gear

### Made to Measure doors add £258

#### Size availability (mm) for Made to Measure doors

Minimum width	-	3049	3049	-
Maximum width	-	4877	4877	-
Minimum height	-	1880	1880	-
Maximum height	-	2286	2195	-

\*Bedford doors below 12' 6" are produced with 3 panels

For Steel Up & Over Door options see page 11

## Cardale powder coated pre-finished double steel doors

### Standard size double doors Pre-finished white

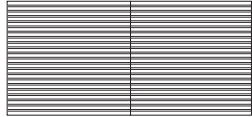
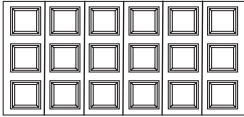
Size mm (ft/in) Width by Height			
	<b>Europa II</b>	<b>Gemini</b>	<b>Georgian</b>
	R	R	R
3200 x 1981 (10'6" x 6'6")	1544	1620	1827
3200 x 2134 (10'6" x 7'0")	1544	1620	1827
3353 x 1981 (11'0" x 6'6")	1580	1657	1886
3353 x 2134 (11'0" x 7'0")	1580	1657	1886
3505 x 1981 (11'6" x 6'6")	1629	1943	1943
3505 x 2134 (11'6" x 7'0")	1629	1943	1943
3658 x 1981 (12'0" x 6'6")	1671	2002	2002
3658 x 2134 (12'0" x 7'0")	1671	2002	2002
3810 x 1981 (12'6" x 6'6")	1712	1797	2061
3810 x 2134 (12'6" x 7'0")	1712	1797	2061
3962 x 1981 (13'0" x 6'6")	1754	1840	2232
3962 x 2134 (13'0" x 7'0")	1754	1840	2232
4115 x 1981 (13'6" x 6'6")	1797	1885	2232
4115 x 2134 (13'6" x 7'0")	1797	1885	2232
4267 x 1981 (14'0" x 6'6")	1649	1649	2062
4267 x 2134 (14'0" x 7'0")	1649	1649	2062
4420 x 1981 (14'6" x 6'6")	1852	1942	2275
4420 x 2134 (14'6" x 7'0")	1852	1942	2275
4572 x 1981 (15'0" x 6'6")	1894	1987	2305
4572 x 2134 (15'0" x 7'0")	1894	1987	2305
4877 x 1981 (16'0" x 6'6")	1936	2031	2660
4877 x 2134 (16'0" x 7'0")	1936	2031	2660

R = Retractable gear.

### Made to Measure doors add £258

#### Size availability (mm) for Made to Measure doors

Minimum width	3049	3049	3049
Maximum width	4267	4877	4877
Minimum height	1880	1880	1930
Maximum height	2286	2286	2169

For Steel Up & Over Door options see page 11

# STEEL DOUBLE UP & OVER DOORS

## Cardale powder coated pre-finished double steel doors

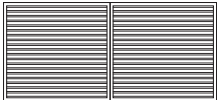
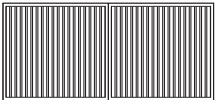
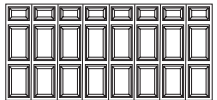
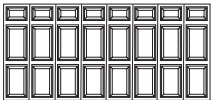
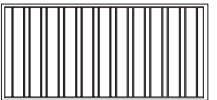
Standard size double doors Pre-finished white					
	Orion Horizontal	Orion Vertical	Sheraton II	Sheraton II glazed	Vogue
Size mm (ft/in) Width by Height	R	R	R	R	
3200 x (10'6" x 6'6")	1827	1883	1827	2339	1886
3200 x (10'6" x 7'0")	1827	1883	1827	2339	1886
3353 x (11'0" x 6'6")	1886	1942	1886	2399	2098
3353 x (11'0" x 7'0")	1886	1942	1886	2399	2098
3505 x (11'6" x 6'6")	1943	2000	1943	2457	2149
3505 x (11'6" x 7'0")	1943	2000	1943	2457	2149
3658 x (12'0" x 6'6")	2002	2059	2002	2515	2202
3658 x (12'0" x 7'0")	2002	2059	2002	2515	2202
3810 x (12'6" x 6'6")	2061	2118	2061	2573	2266
3810 x (12'6" x 7'0")	2061	2118	2061	2573	2266
3962 x (13'0" x 6'6")	2232	2288	2232	2745	2337
3962 x (13'0" x 7'0")	2232	2288	2232	2745	2337
4115 x (13'6" x 6'6")	2232	2288	2232	2745	2470
4115 x (13'6" x 7'0")	2232	2288	2232	2745	2470
4267 x (14'0" x 6'6")	2415	2415	1878	2392	2147
4267 x (14'0" x 7'0")	2415	2415	1878	2392	2147
4420 x (14'6" x 6'6")	2039	2096	2039	2552	2606
4420 x (14'6" x 7'0")	2039	2096	2039	2552	2606
4572 x (15'0" x 6'6")	2305	2360	2305	2817	2664
4572 x (15'0" x 7'0")	2305	2360	2305	2817	2664
4877 x (16'0" x 6'6")	2660	2715	2660	3171	2935
4877 x (16'0" x 7'0")	2660	2715	2660	3171	2935

R = Retractable gear.

### Made to Measure doors add £258

### Size availability (mm) for Made to Measure doors

Minimum width	-	-	3049	3049	3049
Maximum width	-	-	4877	4877	4877
Minimum height	-	-	1880	1880	1880
Maximum height	-	-	2195	2195	2286

For Steel Up & Over Door options see page 11

## STEEL DOUBLE UP & OVER DOORS - OPTIONS

### Cardale powder coated pre-finished steel double doors - OPTIONS

#### Steel up & over double doors - options

Standard frame	add £191
Coloured frame	add £361
Cardale DC650T operator	add £511
Cardale DC800T operator	add £663
Glazing (Brompton & Georgian)	add £672
Painted door (Bedford)	add £127 (White) add £263 (Colours)

#### Steel doors including windows.

The standard colour window frame for white coloured doors is white. For non-white coloured doors and for Rosewood and Golden Oak laminated doors the window frame colour will be black.

Colour matched window frames are available but must be specified at time of order.

Colour matched window frames (except Bedford)	add £361 per window
Colour matched window frames for Bedford	add £270 per door

#### Optional extras for operators

Extra handsets	add £77 (2 channel) add £85 (4 channel)
Wireless key pad	add £211
External manual override	add £48
Keyswitch	add £51

Frames ordered with a double door will be supplied as a separate knocked down item.

**All steel up & over doors are bespoke and made to order.**

#### Colours available for steel doors:

RAL 7038	Ageta Grey
RAL 7016	Anthracite Grey
RAL 6005	Balmoral Green
RAL 8017	Conker Brown
RAL 9011	Graphite Black
RAL 9004	Signal Black
RAL 9005	Ebony Black
RAL 7035	Light Grey
RAL 5013	Oxford Blue
RAL 5011	Midnight Blue
RAL 3003	Monarch Red
RAL 3009	Oxide Red
RAL 8003	Signal Brown
RAL 7004	Signal Grey
RAL 5024	Pastel Blue
RAL 6009	Fir Green
RAL 6013	Reed Green
BS4800-14C35	Chartwell Green
BS4800-12B17	Willow Green
BS381-420	Dark Camouflage Desert Sand
BS381-389	Camouflage Beige
RAL 9001	Cream
Cherry - Master Chroma 3353	

Cardale doors are supplied white RAL 9016 as standard.

# STEEL SINGLE UP & OVER DOORS

## Cardale Golden Oak and Rosewood finished single steel doors

**Standard size  
single doors  
Golden Oak or  
Rosewood finished**

Size mm (ft/in)  
Width by Height

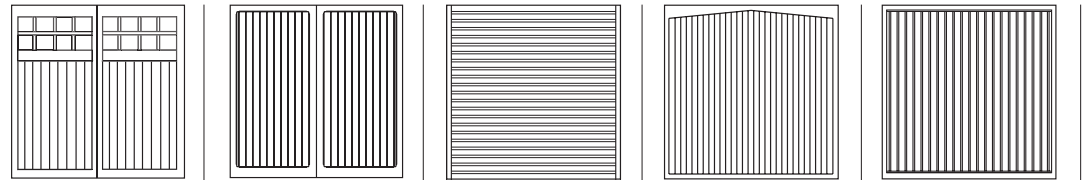

Size mm (ft/in) Width by Height	<b>Bedford</b>		<b>Berkeley Vertical</b>		<b>Europa II</b>		<b>Gatcombe</b>		<b>Gemini</b>	
	C	R	C	R	C	R	C	R	C	R
1981 x 1981 (6'6" x 6'6")	-	-	1401	1465	796	860	1401	1465	898	962
1981 x 2134 (6'6" x 7'0")	-	-	1401	1465	796	860	1401	1465	898	962
2083 x 1905 (6'10" x 6'3")	-	-	1401	1465	796	860	1401	1465	898	962
2083 x 1930 (6'10" x 6'4")	-	-	1401	1465	796	860	1401	1465	898	962
2083 x 1956 (6'10" x 6'5")	-	-	1401	1465	796	860	1401	1465	898	962
2083 x 1981 (6'10" x 6'6")	-	-	1401	1465	796	860	1401	1465	898	962
2108 x 1981 (6'11" x 6'6")	1401	1465	1401	1465	796	860	1401	1465	898	962
2108 x 2134 (6'11" x 7'0")	1401	1465	1401	1465	796	860	1401	1465	898	962
2134 x 1828 (7'0" x 6'0")	1401	1465	1401	1465	796	860	1401	1465	898	962
2134 x 1880 (7'0" x 6'2")	1401	1465	1401	1465	796	860	1401	1465	898	962
2134 x 1905 (7'0" x 6'3")	1401	1465	1401	1465	796	860	1401	1465	898	962
2134 x 1930 (7'0" x 6'4")	1401	1465	1401	1465	796	860	1401	1465	898	962
2134 x 1981 (7'0" x 6'6")	1401	1465	1401	1465	796	860	1401	1465	898	962
2134 x 2134 (7'0" x 7'0")	1410	1475	1410	1475	849	913	1410	1475	919	983
2210 x 1930 (7'3" x 6'4")	1446	1510	1446	1510	885	948	1446	1510	966	1030
2261 x 1981 (7'5" x 6'6")	1446	1510	1446	1510	885	948	1446	1510	966	1030
2261 x 2134 (7'5" x 7'0")	1446	1510	1446	1510	885	948	1446	1510	966	1030
2286 x 1828 (7'6" x 6'0")	1446	1510	1446	1510	885	948	1446	1510	966	1030
2286 x 1905 (7'6" x 6'3")	1446	1510	1446	1510	885	948	1446	1510	966	1030
2286 x 1981 (7'6" x 6'6")	1446	1510	1446	1510	885	948	1446	1510	966	1030
2286 x 2134 (7'6" x 7'0")	1451	1515	1451	1515	984	1057	1451	1515	1041	1106
2438 x 1905 (8'0" x 6'3")	1541	1603	1524	1588	994	1057	1524	1588	1106	1170
2438 x 1930 (8'0" x 6'4")	1541	1603	1524	1588	994	1057	1524	1588	1106	1170
2438 x 1981 (8'0" x 6'6")	1541	1603	1524	1588	994	1057	1524	1588	1106	1170
2438 x 2134 (8'0" x 7'0")	1544	1608	1524	1588	980	1045	1524	1588	1143	1208
2743 x 1981 (9'0" x 6'6")	-	-	-	1834	-	1869	-	-	-	1443
2743 x 2134 (9'0" x 7'0")	-	-	-	1834	-	1869	-	-	-	1443
2896 x 1981 (9'6" x 6'6")	-	-	-	1834	-	2031	-	-	-	1606
2896 x 2134 (9'6" x 7'0")	-	-	-	1834	-	2031	-	-	-	1606
3048 x 1981 (10'0" x 6'6")	-	-	-	1834	-	2191	-	-	-	1664
3048 x 2134 (10'0" x 7'0")	-	-	-	1834	-	2191	-	-	-	1664

C = Canopy gear, R = Retractable gear

**Made to Measure doors add £174**

**Size availability (mm) for Made to Measure doors**

Minimum width	2083	2083	1981	1981	1981	1981	1981	1981	1981	1981
Maximum width	2438	2438	2438	2438	2438	3048	2438	2438	2438	3048
Minimum height	1829	1860	1829	1860	1829	1918*	1829	1860	1829	1860
Maximum height	2134	2286	2134	2286	2134	2286	2134	2286	2134	2286

**All Golden Oak and Rosewood doors are bespoke and made to order.**

## Cardale Golden Oak and Rosewood finished single steel doors

### Standard size single doors Golden Oak or Rosewood finished

Size mm (ft/in)  
Width by Height

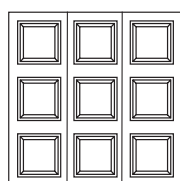

**Georgian**

C R

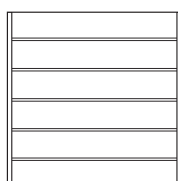

**Haven**

C R

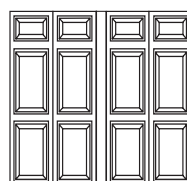

**Sheraton II**

C R

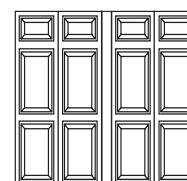

**Sheraton II glazed**

C R

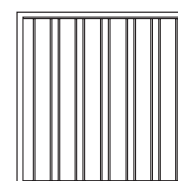

**Vogue**

C R

1981 x 1981	[6'6" x 6'6"]	1069	1081	824	885	915	976	970	1031	989	1051
1981 x 2134	[6'6" x 7'0"]	1020	1081	824	885	915	976	970	1031	989	1051
2083 x 1905	[6'10" x 6'3"]	-	-	864	927	959	1023	1017	1080	1036	1101
2083 x 1930	[6'10" x 6'4"]	1069	1133	864	927	959	1023	1017	1080	1036	1101
2083 x 1956	[6'10" x 6'5"]	1069	1133	864	927	959	1023	1017	1080	1036	1101
2083 x 1981	[6'10" x 6'6"]	1069	1133	864	927	959	1023	1017	1080	1036	1101
2108 x 1981	[6'11" x 6'6"]	1069	1133	864	927	959	1023	1017	1080	1036	1101
2108 x 2134	[6'11" x 7'0"]	1069	1133	864	927	959	1023	1017	1080	1036	1101
2134 x 1828	[7'0" x 6'0"]	1069	1133	864	927	959	1023	1017	1080	1036	1101
2134 x 1880	[7'0" x 6'2"]	1069	1133	864	927	959	1023	1017	1080	1036	1101
2134 x 1905	[7'0" x 6'3"]	-	-	864	927	959	1023	1017	1080	1036	1101
2134 x 1930	[7'0" x 6'4"]	1069	1133	864	927	959	1023	1017	1080	1036	1101
2134 x 1981	[7'0" x 6'6"]	1069	1133	864	927	959	1023	1017	1080	1036	1101
2134 x 2134	[7'0" x 7'0"]	1118	1182	944	1008	1049	1113	1112	1176	1067	1131
2210 x 1930	[7'3" x 6'4"]	1182	1246	964	1028	1071	1135	1135	1199	1173	1237
2261 x 1981	[7'5" x 6'6"]	1182	1246	964	1028	1071	1135	1135	1199	1173	1237
2261 x 2134	[7'5" x 7'0"]	1182	1246	964	1028	1071	1135	1135	1199	1173	1237
2286 x 1828	[7'6" x 6'0"]	1182	1246	964	1028	1071	1135	1135	1199	1173	1237
2286 x 1905	[7'6" x 6'3"]	-	-	964	1028	1071	1135	1135	1199	1173	1237
2286 x 1981	[7'6" x 6'6"]	1182	1246	964	1028	1071	1135	1135	1199	1173	1237
2286 x 2134	[7'6" x 7'0"]	1350	1414	1058	1122	1174	1238	1244	1308	1173	1237
2438 x 1905	[8'0" x 6'3"]	-	-	1112	1176	1233	1297	1308	1373	1236	1300
2438 x 1930	[8'0" x 6'4"]	1395	1459	1112	1176	1233	1297	1308	1373	1236	1300
2438 x 1981	[8'0" x 6'6"]	1395	1459	1112	1176	1233	1297	1308	1373	1235	1300
2438 x 2134	[8'0" x 7'0"]	1395	1459	1148	1213	1276	1338	1351	1417	1276	1338
2743 x 1981	[9'0" x 6'6"]	-	1551	-	-	-	2241	-	2396	-	1868
2743 x 2134	[9'0" x 7'0"]	-	1551	-	-	-	2241	-	2419	-	1868
2896 x 1981	[9'6" x 6'6"]	-	1608	-	-	-	2319	-	2458	-	1934
2896 x 2134	[9'6" x 7'0"]	-	1608	-	-	-	2319	-	2506	-	1934
3048 x 1981	[10'0" x 6'6"]	-	1955	-	-	-	2398	-	2541	-	1997
3048 x 2134	[10'0" x 7'0"]	-	1955	-	-	-	2398	-	2590	-	1997

C = Canopy gear, R = Retractable gear

### Made to Measure doors add £174

#### Size availability (mm) for Made to Measure doors

Minimum width	1981	1981	1981	1981	1981	1981	1981	1981	1981	1981
Maximum width	2438	3048	2438	2438	2438	3048	2438	3048	2438	3048
Minimum height	1914	1914	1829	1860	1868	1868	1868	1868	1829	1860
Maximum height	2158	2158	2134	2286	2181	2181	2181	2181	2134	2286

All Golden Oak and Rosewood doors are bespoke and made to order.

## STEEL SINGLE UP & OVER DOORS

### Cardale Golden Oak and Rosewood finished single steel doors - OPTIONS

#### Golden Oak & Rosewood single doors - options

Standard white frame	add £134
Coloured frame	add £184 (Golden Oak, Clay Brown RAL 8003, Rosewood, Cherry, Master Chroma 3353)
Cardale DC650T operator	add £511
Cardale DC800T operator	add £663
Glazing (Bedford)	add £168 (Stippled). Black mock glazing standard
Glazing (Georgian)	add £339
Glazing (Sheraton II)	Plain black, Stippled, Transparent, Diamond lattice, Queen Anne lattice, Square lattice (Sheraton II only at no extra cost)

#### Steel doors including windows.

The standard colour window frame for non-white coloured doors and for Rosewood and Golden Oak laminated doors the window frame colour will be black. Colour matched window frames are available but must be specified at time of order.

Colour matched window frames (except Bedford)	add £35 per window
Colour matched window frames for Bedford	add £140 per door

# STEEL DOUBLE UP & OVER DOORS

## Cardale Golden Oak and Rosewood finished double steel doors

**Standard size  
double doors  
Golden Oak or Rosewood  
finished**

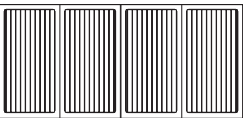
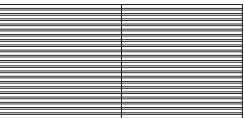
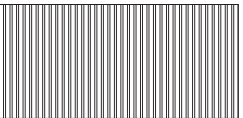
	 <b>Bedford*</b>	 <b>Berkeley Vertical</b>	 <b>Europa II</b>	 <b>Gemini</b>
Size mm (ft/in) Width by Height	R	R	R	R
3200 x 1981 (10'6" x 6'6")	2192	1863	1935	1852
3200 x 2134 (10'6" x 7'0")	2192	1863	1935	1852
3353 x 1981 (11'0" x 6'6")	2263	1923	2027	1887
3353 x 2134 (11'0" x 7'0")	2263	1923	2027	1887
3505 x 1981 (11'6" x 6'6")	-	1983	2103	1936
3505 x 2134 (11'6" x 7'0")	-	1983	2103	1936
3658 x 1981 (12'0" x 6'6")	-	2043	2185	1978
3658 x 2134 (12'0" x 7'0")	-	2043	2185	1978
3810 x 1981 (12'6" x 6'6")	-	2103	2242	2017
3810 x 2134 (12'6" x 7'0")	-	2103	2242	2017
3962 x 1981 (13'0" x 6'6")	-	2415	2300	2060
3962 x 2134 (13'0" x 7'0")	-	2415	2300	2060
4115 x 1981 (13'6" x 6'6")	2899	2415	2441	2102
4115 x 2134 (13'6" x 7'0")	2899	2415	2441	2102
4267 x 1981 (14'0" x 6'6")	2899	2465	2188	1877
4267 x 2134 (14'0" x 7'0")	2899	2465	2188	1877
4420 x 1981 (14'6" x 6'6")	3043	2799	2680	2158
4420 x 2134 (14'6" x 7'0")	3043	2799	2680	2158
4572 x 1981 (15'0" x 6'6")	3189	2799	2799	2199
4572 x 2134 (15'0" x 7'0")	3189	2799	2799	2199
4877 x 1981 (16'0" x 6'6")	3478	2799	2799	2242
4877 x 2134 (16'0" x 7'0")	3478	2799	2799	2242

**\*Bedford doors below 12' 6" are produced with 3 panels**

R = Retractable gear

**Made to Measure doors add £258**

**Size availability (mm) for Made to Measure doors**

Minimum width	-	-	2500	2500
Maximum width	-	-	4374	4999
Minimum height	-	-	1927	1927
Maximum height	-	-	2343	2343

# STEEL DOUBLE UP & OVER DOORS

## Cardale Golden Oak and Rosewood finished double steel doors

### Standard size double doors Golden Oak or Rosewood finished

Size mm (ft/in)  
Width by Height

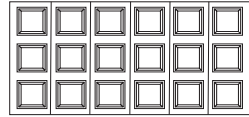

**Georgian**

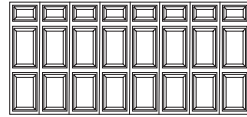

**Sheraton II**

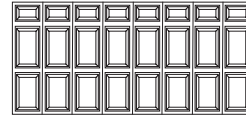

**Sheraton II glazed**

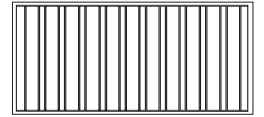

**Vogue**

Size mm (ft/in) Width by Height	R	R	R	R
3200 x 1981 (10'6" x 6'6")	3200	2648	2861	2207
3200 x 2134 (10'6" x 7'0")	2049	2648	2861	2207
3353 x 1981 (11'0" x 6'6")	2103	2904	3137	2420
3353 x 2134 (11'0" x 7'0")	2103	2904	3137	2420
3505 x 1981 (11'6" x 6'6")	2160	2931	3165	2443
3505 x 2134 (11'6" x 7'0")	2160	2931	3165	2443
3658 x 1981 (12'0" x 6'6")	2215	3031	3273	2525
3658 x 2134 (12'0" x 7'0")	2215	3031	3273	2525
3810 x 1981 (12'6" x 6'6")	2272	3064	3311	2591
3810 x 2134 (12'6" x 7'0")	2272	3064	3311	2591
3962 x 1981 (13'0" x 6'6")	2295	3189	3444	2658
3962 x 2134 (13'0" x 7'0")	2295	3189	3444	2658
4115 x 1981 (13'6" x 6'6")	2317	3353	3620	2793
4115 x 2134 (13'6" x 7'0")	2317	3353	3620	2793
4267 x 1981 (14'0" x 6'6")	2339	2962	3200	2469
4267 x 2134 (14'0" x 7'0")	2339	2962	3200	2469
4420 x 1981 (14'6" x 6'6")	2350	3514	3795	2927
4420 x 2134 (14'6" x 7'0")	2350	3514	3795	2927
4572 x 1981 (15'0" x 6'6")	2385	3583	3869	2986
4572 x 2134 (15'0" x 7'0")	2385	3583	3869	2986
4877 x 1981 (16'0" x 6'6")	2459	3911	4224	3259
4877 x 2134 (16'0" x 7'0")	2459	3911	4224	3259

R = Retractable gear

### Made to Measure doors add £258

#### Size availability (mm) for Made to Measure doors

Minimum width	3049	3049	3049	3049
Maximum width	4877	4877	4877	4877
Minimum height	1930	1880	1880	1927
Maximum height	2158	2195	2195	2195

For Steel Up & Over Door options see page 17

## GOLDEN OAK AND ROSEWOOD FINISHED STEEL DOORS - OPTIONS

### Cardale Golden Oak and Rosewood finished steel doors - OPTIONS

#### Golden Oak & Rosewood double doors - options

Standard white frame	add £238
Coloured frame	add £362 (Golden Oak, Clay Brown RAL 8003, Rosewood, Cherry, Master Chroma 3353)
Cardale DC650T operator	add £511
Cardale DC800T operator	add £663
Glazing (Bedford)	add £322 (Stippled) Black mock glazing standard
Glazing (Georgian)	add £670 (Stippled or plain)
Glazing (Sheraton II)	Plain black, Stippled, Transparent, Diamond lattice, Queen Anne lattice, Square lattice (Sheraton II only at no extra cost)

#### Steel doors including windows.

The standard colour window frame for Rosewood and Golden Oak laminated doors will be black. Colour matched window frames are available but must be specified at time of order.

Colour matched window frames (except Bedford)	add £35 per window
Colour matched window frames for Bedford	add £270 per door

#### Optional extras for operators

Extra handsets	add £77 (2 channel) add £85 (4 channel)
Wireless key pad	add £211
External manual override	add £48
Keyswitch	add £51

Frames ordered with a double door will be supplied as a separate knocked down item.

**Frames for Golden Oak finished doors are Clay Brown RAL 8003**

**Frames for Rosewood finished doors are Cherry - Master Chroma 3353**

**All Golden Oak and Rosewood doors are bespoke and made to order.**

# STEEL SECURED BY DESIGN DOORS

## Cardale Secured by Design steel single doors



Official Police Security Initiative

Cardale Secured by Design doors are certificated to CS 9051 STS202 which is approved by ACPD Association Of Chief Police Officers.

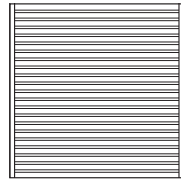

**Europa II**

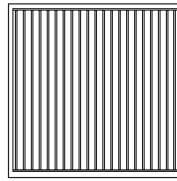

**Gemini**

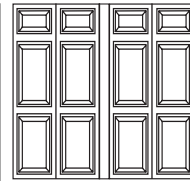

**Sheraton II**

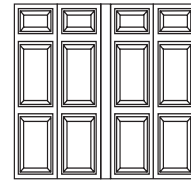

**Sheraton II glazed**

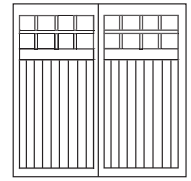

**Bedford**

Size mm (ft/in) Width by Height

		Europa II R	Gemini R	Sheraton II C	Sheraton II glazed R	Bedford R
1981 x 1830	6'6" x 6'0"	1113	1200	-	-	-
1981 x 1905	6'6" x 6'3"	1132	1200	1417	1769	-
1981 x 1930	6'6" x 6'4"	1132	1220	1369	1721	-
1981 x 1981	6'6" x 6'6"	1136	1220	1369	1721	-
2085 x 1930	6'10" x 6'4"	1147	1232	1369	1721	-
2085 x 1981	6'10" x 6'6"	1157	1232	1369	1721	-
2085 x 2134	6'10" x 7'0"	1157	1300	1369	1721	1701
2083 x 2210	6'10" x 7'3"	1157	1300	-	-	1701
2083 x 2286	6'10" x 7'6"	1157	1236	-	-	1701
2134 x 1830	7'0" x 6'0"	1157	1236	-	-	1701
2134 x 1905	7'0" x 6'3"	1157	1236	1369	1721	1701
2134 x 1930	7'0" x 6'4"	1157	1236	1369	1721	1701
2134 x 1981	7'0" x 6'6"	1096	1198	1366	1718	1701
2134 x 2134	7'0" x 7'0"	1148	1302	1415	1768	1707
2134 x 2210	7'0" x 7'3"	1180	1272	-	-	1746
2134 x 2286	7'0" x 7'6"	1180	1289	-	-	1746
2225 x 1930	7'3" x 6'4"	1291	1372	1694	2046	1746
2225 x 1981	7'3" x 6'6"	1184	1265	1472	1826	1746
2225 x 2134	7'3" x 7'0"	1184	1265	1472	1826	1746
2210 x 2210	7'3" x 7'3"	1184	1264	-	-	1746
2210 x 2286	7'3" x 7'6"	1284	1340	-	-	1750
2260 x 1930	7'5" x 6'4"	1257	1376	1675	2028	1819
2260 x 1981	7'5" x 6'6"	1291	1403	1675	2028	1819
2260 x 2134	7'5" x 7'0"	1291	1403	1694	2046	1819
2261 x 2210	7'5" x 7'3"	1307	1442	-	-	1824
2261 x 2286	7'5" x 7'6"	2040	2072	-	-	2569
2285 x 1930	7'6" x 6'4"	1651	1699	1877	2134	2138
2285 x 1981	7'6" x 6'6"	1651	1699	1877	2134	2138
2285 x 2134	7'6" x 7'0"	1752	1773	1952	2207	2152
2286 x 2210	7'6" x 7'3"	1949	1974	-	-	2410
2286 x 2286	7'6" x 7'6"	2071	2100	-	-	2569
2438 x 1930	8'0" x 6'4"	1812	1807	1980	2230	2170
2438 x 1981	8'0" x 6'6"	1909	1807	1980	2230	2170
2438 x 2134	8'0" x 7'0"	1944	1807	2010	2259	2182
2438 x 2210	8'0" x 7'3"	2173	2014	-	-	2446
2438 x 2286	8'0" x 7'6"	2313	2141	-	-	2608

Minimum width	1981	1981	1981	1981	2083
Maximum width	2438	2438	2438	2438	2438
Minimum height	1829	1829	1868	1868	1800
Maximum height	2286	2286	2134	2134	2286

## Secured by Design



### Official Police Security Initiative

Cardale Secured by Design doors are certificated to CS 5051 STS202 which is approved by ACPO Association Of Chief Police Officers.

Cardale Secured by Design garage doors have spring assisted retractable action for smooth running. Factory fitted steel frames as standard 70mm wide. Cardale Secured by Design Up & Over garage doors can only be supplied in a pre-hung factory finished steel fixing frame, which makes installation simple and eliminates the need for a timber frame. These frames are supplied as standard in white, however colour matched frames are also available. Supplied with our black "D" handle.

**Secured by Design doors are bespoke and made to order.**

### Secured by Design doors - options

Matching coloured frame add £171  
Painted door panel add £119 (Colours)

### Steel doors including windows.

The standard colour window frame for white coloured doors is white. For non-white coloured doors the window frame colour will be black.

Colour matched window frames are available but must be specified at time of order.

Colour matched window frames (except Bedford) add £35 per window  
Colour matched window frames for Bedford add £140 per door

### Optional extras for operators

Extra handsets add £77 (2 channel)  
add £85 (4 channel)  
Wireless key pad add £211  
External manual override add £48  
Keyswitch add £51

R = Retractable

See page 37 for Timber Secure by Design doors

### Colours available:

RAL 7038 Ageta Grey  
RAL 7016 Anthracite Grey  
RAL 6005 Balmoral Green  
RAL 8017 Conker Brown  
RAL 9011 Graphite Black  
RAL 9004 Signal Black  
RAL 9005 Ebony Black  
RAL 7035 Light Grey  
RAL 5013 Oxford Blue  
RAL 5011 Midnight Blue  
RAL 3003 Monarch Red  
RAL 3009 Oxide Red  
RAL 8003 Signal Brown  
RAL 7004 Signal Grey  
RAL 5024 Pastel Blue  
RAL 6009 Fir Green  
RAL 6013 Reed Green  
BS4800-14C35 Chartwell Green  
BS4800-12B17 Willow Green  
BS381-420 Dark Camouflage Desert Sand  
BS381-389 Camouflage Beige  
RAL 9001 Cream  
Cherry - Master Chroma 3353

Cardale doors are supplied white RAL 9016 as standard.

## STEEL SIDE HINGED DOORS

### Cardale powder coated pre-finished side hinged steel doors

#### Side hinged steel single doors Pre-finished white Standard sizes

Size mm (ft/in)  
Width by Height

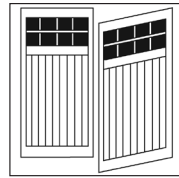

**Bedford**  
(1/2 - 1/2)

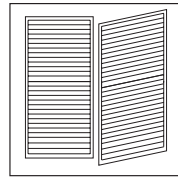

**Berkeley Horizontal**  
(1/2 - 1/2)

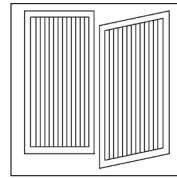

**Berkeley Vertical**  
(1/2 - 1/2)

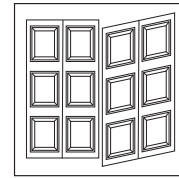

**Brompton**  
(1/2 - 1/2)

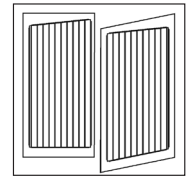

**Gatcombe**  
(1/2 - 1/2)

Size mm (ft/in) Width by Height	Bedford (1/2 - 1/2)	Berkeley Horizontal (1/2 - 1/2)	Berkeley Vertical (1/2 - 1/2)	Brompton (1/2 - 1/2)	Gatcombe (1/2 - 1/2)
1981 x 1981 (6'6" x 6'6")	-	1623	-	1413	1623
1981 x 2134 (6'6" x 7'0")	-	1623	-	1413	1623
2134 x 1981 (7'0" x 6'6")	1766	1623	1623	1413	1623
2134 x 2134 (7'0" x 7'0")	1810	1666	1666	1457	1525
2286 x 1981 (7'6" x 6'6")	1877	1734	1734	1525	1593
2286 x 2134 (7'6" x 7'0")	1988	1847	1847	1637	1703
2438 x 1981 (8'0" x 6'6")	2031	1888	1888	1678	1747
2438 x 2134 (8'0" x 7'0")	2117	1975	1975	1718	1786

#### Made to Measure doors add £174

#### Size availability (mm) for Made to Measure doors

Minimum width	2134	1750	1750	1829	1750
Maximum width	2438	2438	2438	2438	2438
Minimum height	1775	1775	1775	1864	1775
Maximum height	2286	2286	2286	2179	2286

#### Steel side hinged doors - options

Unframed	deduct £39
Painted frame	add £29
Glazing (Bedford)	add £160 (Stippled) Black mock glazing standard
Glazing (Brompton & Georgian)	add £338 (Stippled, Diamond Lattice, Square Lattice and Plain)
Painted door	add £134
Left hand opening	add £78
Side hinged doors supplied with pre-finished white 50mm frame as standard.	
Doors supplied as standard right hand opening when viewed from outside.	
All side hinged doors are only available opening outwards.	

The standard handle pack includes a Cardale handle and a Black lever handle.

All doors are supplied as standard with 1 pair of door stays. Top and bottom shoot bolts.

Chassis and fixing frames are supplied in Brown RAL 8017 as standard.

#### Colours available:

RAL 7038	Ageta Grey
RAL 7016	Anthracite Grey
RAL 6005	Balmoral Green
RAL 8017	Conker Brown
RAL 9011	Graphite Black
RAL 9004	Signal Black
RAL 9005	Ebony Black
RAL 7035	Light Grey
RAL 5013	Oxford Blue
RAL 5011	Midnight Blue
RAL 3003	Monarch Red
RAL 3009	Oxide Red
RAL 8003	Signal Brown
RAL 7004	Signal Grey
RAL 5024	Pastel Blue
RAL 6009	Fir Green
RAL 6013	Reed Green
BS4800-14C35	Chartwell Green
BS4800-12B17	Willow Green
BS381-420	Dark Camouflage Desert Sand
BS381-389	Camouflage Beige
Cherry - Master Chroma 3353	

Cardale doors are supplied white RAL 9016 as standard.

**All side hinged doors come complete with a pair of door stays.**

**Doors are supplied as standard with one black lever style and one Cardale handle.**

**All side hinged doors are bespoke and made to order.**

## Cardale powder coated pre-finished side hinged steel doors

### Side hinged steel single doors Pre-finished white Standard sizes

Size mm (ft/in)  
Width by Height

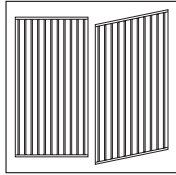

**Gemini**  
( $\frac{2}{3}$  -  $\frac{1}{3}$ ) ( $\frac{1}{2}$  -  $\frac{1}{2}$ )

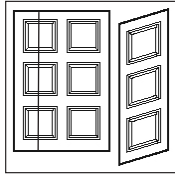

**Georgian**  
( $\frac{2}{3}$  -  $\frac{1}{3}$ )

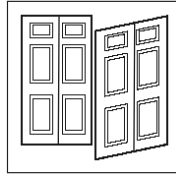

**Sheraton II**  
( $\frac{1}{2}$  -  $\frac{1}{2}$ )

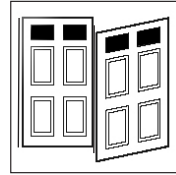

**Sheraton II glazed**  
( $\frac{1}{2}$  -  $\frac{1}{2}$ )

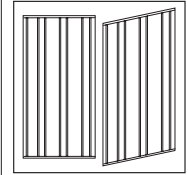

**Vogue**  
( $\frac{1}{2}$  -  $\frac{1}{2}$ )

Size mm (ft/in) Width by Height	Gemini ( $\frac{2}{3}$ - $\frac{1}{3}$ ) ( $\frac{1}{2}$ - $\frac{1}{2}$ )	Georgian ( $\frac{2}{3}$ - $\frac{1}{3}$ )	Sheraton II ( $\frac{1}{2}$ - $\frac{1}{2}$ )	Sheraton II glazed ( $\frac{1}{2}$ - $\frac{1}{2}$ )	Vogue ( $\frac{1}{2}$ - $\frac{1}{2}$ )
1981 x 1981 (6'6" x 6'6")	1291	1397	1685	1876	1646
1981 x 2134 (6'6" x 7'0")	1306	1397	1720	1911	1663
2134 x 1981 (7'0" x 6'6")	1265	1413	1663	1854	1612
2134 x 2134 (7'0" x 7'0")	1335	1457	1756	1949	1699
2286 x 1981 (7'6" x 6'6")	1370	1525	1787	1979	1739
2286 x 2134 (7'6" x 7'0")	1444	1637	1791	2086	1840
2438 x 1981 (8'0" x 6'6")	1463	1678	1800	1992	1851
2438 x 2134 (8'0" x 7'0")	1481	1718	1824	2015	1874

### Made to Measure doors add £174

#### Size availability (mm) for Made to Measure doors

Minimum width	1750	1958	1829	1829	1750
Maximum width	2438	2438	2438	2438	2438
Minimum height	1775	1911	1864	1864	1775
Maximum height	2286	2155	2179	2179	2286

## STEEL SIDE HINGED DOORS

### Cardale Golden Oak or Rosewood finished side hinged steel doors

#### Side hinged steel single doors Golden Oak or Rosewood finished Standard sizes

Size mm (ft/in)  
Width by Height

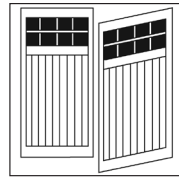

**Bedford**  
(1/2 - 1/2)

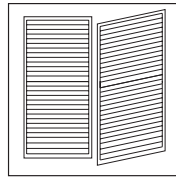

**Berkeley Horizontal**  
(1/2 - 1/2)

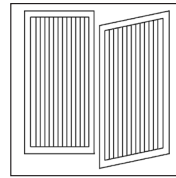

**Berkeley Vertical**  
(1/2 - 1/2)

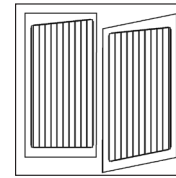

**Gatcombe**  
(1/2 - 1/2)

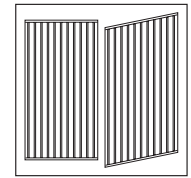

**Gemini**  
(2/3 - 1/3) (1/2 - 1/2)

Size mm (ft/in) Width by Height	Bedford (1/2 - 1/2)	Berkeley Horizontal (1/2 - 1/2)	Berkeley Vertical (1/2 - 1/2)	Gatcombe (1/2 - 1/2)	Gemini (2/3 - 1/3) (1/2 - 1/2)
1981 x 1981 (6'6" x 6'6")	-	1818	1818	1676	1527
1981 x 2134 (6'6" x 7'0")	-	1818	1818	1676	1527
2134 x 1981 (7'0" x 6'6")	1961	1818	1818	1676	1527
2134 x 2134 (7'0" x 7'0")	2005	1862	1862	1721	1600
2286 x 1981 (7'6" x 6'6")	2075	1931	1931	1789	1633
2286 x 2134 (7'6" x 7'0")	2188	2045	2045	1903	1707
2438 x 1981 (8'0" x 6'6")	2228	2086	2086	1942	1725
2438 x 2134 (8'0" x 7'0")	2265	2125	2125	1982	1746

#### Made to Measure doors add £174

#### Size availability (mm) for Made to Measure doors

Minimum width	2134	1750	1750	1750	1750
Maximum width	2438	2438	2438	2438	2438
Minimum height	1775	1775	1775	1775	1775
Maximum height	2286	2286	2286	2286	2286

#### Golden Oak & Rosewood side hinged doors - options

Unframed	deduct £39
Painted frame	add £29
Glazing (Bedford)	add £160 (Stippled) Black mock glazing standard
Glazing (Georgian)	add £338 (Stippled, Diamond Lattice, Square Lattice and Plain)
Left hand opening	add £78

Side hinged doors supplied with pre-finished 50mm frame as standard.

Doors supplied as standard right hand opening when viewed from outside.

All side hinged doors are only available opening outwards.

The standard handle pack includes a Cardale handle and a Black lever handle.

All doors are supplied as standard with 1 pair of door stays. Top and bottom shoot bolts.

Frames for Golden Oak finished doors are Clay Brown RAL 8003  
Frames for Rosewood finished doors are Cherry - Master Chroma 3353

**All side hinged doors come complete with a pair of door stays.**

**Doors are supplied as standard with one black lever style and one Cardale handle.**

**All side hinged doors are bespoke and made to order.**

## Cardale Golden Oak or Rosewood finished side hinged steel doors

### Side hinged steel single doors Golden Oak or Rosewood finished Standard sizes

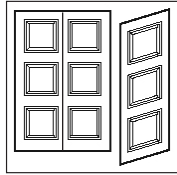

**Georgian**  
( $\frac{2}{3}$  -  $\frac{1}{3}$ )

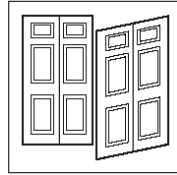

**Sheraton II**  
( $\frac{1}{2}$  -  $\frac{1}{2}$ )

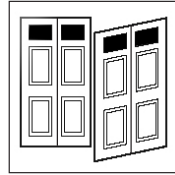

**Sheraton II glazed**  
( $\frac{1}{2}$  -  $\frac{1}{2}$ )

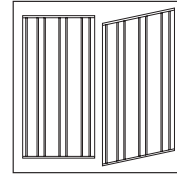

**Vogue**  
( $\frac{1}{2}$  -  $\frac{1}{2}$ )

Size mm (ft/in)  
Width by Height

Size mm (ft/in) Width by Height	Georgian ( $\frac{2}{3}$ - $\frac{1}{3}$ )	Sheraton II ( $\frac{1}{2}$ - $\frac{1}{2}$ )	Sheraton II glazed ( $\frac{1}{2}$ - $\frac{1}{2}$ )	Vogue ( $\frac{1}{2}$ - $\frac{1}{2}$ )
1981 x 1981 (6'6" x 6'6")	1818	1676	1988	1834
1981 x 2134 (6'6" x 7'0")	1818	1676	1988	1834
2134 x 1981 (7'0" x 6'6")	1818	1676	1988	1834
2134 x 2134 (7'0" x 7'0")	1862	1721	2032	1921
2286 x 1981 (7'6" x 6'6")	1931	1789	2102	1957
2286 x 2134 (7'6" x 7'0")	2045	1903	2215	2049
2438 x 1981 (8'0" x 6'6")	2086	1942	2255	2074
2438 x 2134 (8'0" x 7'0")	2086	1982	2294	2094

### Made to Measure doors add £174





#### Size availability (mm) for Made to Measure doors

Minimum width	1959	1829	1829	1750
Maximum width	2438	2438	2438	2438
Minimum height	1911	1864	1864	1775
Maximum height	2155	2179	2179	2286

## STEEL PERSONNEL DOORS

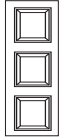
### Cardale powder coated pre-finished steel personnel doors

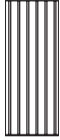
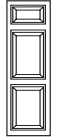
#### Powder coated pre-finished steel personnel doors

					
<b>Georgian</b>	<b>Europa II</b>	<b>Gemini</b>	<b>Sheraton II</b>	<b>Vogue</b>	<b>Haven</b>

Size mm (ft/in) Door opening size

762 x 1981 (2'6" x 6'6")	892 x 2049 (2'11¼" x 6'8¾")	687	677	677	687	687	687
762 x 2134 (2'6" x 7'0")	892 x 2202 (2'11¼" x 7'2¾")	687	677	677	687	687	687
914 x 1981 (3'0" x 6'6")	1044 x 2049 (3'4⅓" x 6'8¾")	842	830	830	842	842	842
914 x 2134 (3'0" x 7'0")	1044 x 2202 (3'4⅓" x 7'2¾")	842	830	830	842	842	842
1219x 1981 (4'0" x 6'6")	1349 x 2049 (4'4⅓" x 6'8¾")	1028	936	936	1028	1028	1028
1219x 2134 (4'0" x 7'0")	1349 x 2202 (4'4⅓" x 7'2¾")	1028	936	936	1028	1028	1028

#### Size availability (mm)

Minimum width	756	419	419	756	419	419
Maximum width	1067	1219	1219	1067	1219	1219
Minimum height	1864	1829	1829	1864	1829	1829
Maximum height	2134	2286	2286	2134	2286	2286

#### Personnel doors - options

Painted frame	£29
Painted door	£132
Glazing (Brompton)	£127 (Stippled or Plain)
Glazing (Regal)	£127 (Stippled, Plain, Diamond Lattice, Square Lattice)

50mm frame available at no extra cost

Personnel doors are supplied with pre-finished white frame as standard

**Made to measure - take next size up and add £70**

**All Personnel doors are bespoke and made to order.**





#### Colours available:

RAL 7038	Ageta Grey	RAL 7004	Signal Grey
RAL 7016	Anthracite Grey	RAL 5024	Pastel Blue
RAL 6005	Balmoral Green	RAL 6009	Fir Green
RAL 8017	Conker Brown	RAL 6013	Reed Green
RAL 9011	Graphite Black	BS4800-14C35	Chartwell Green
RAL 9004	Signal Black	BS4800-12B17	Willow Green
RAL 9005	Ebony Black	BS381-420	Dark Camouflage Desert Sand
RAL 7035	Light Grey	BS381-389	Camouflage Beige
RAL 5013	Oxford Blue	Cherry - Master	Chroma 3353
RAL 5011	Midnight Blue		
RAL 3003	Monarch Red		
RAL 3009	Oxide Red		
RAL 8003	Signal Brown		

Cardale doors are supplied white RAL 9016 as standard.

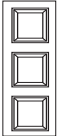
## Cardale Golden Oak or Rosewood finished personnel doors

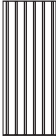
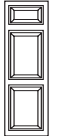
### Powder coated pre-finished steel personnel doors

Size mm (ft/in) Door opening size								
			Georgian	Europa II	Gemini	Sheraton II	Vogue	Haven
762 x 1981	[2'6" x 6'6"]	892 x 2049 [2'11¼" x 6'8¾"]	882	871	871	882	882	882
762 x 2134	[2'6" x 7'0"]	892 x 2202 [2'11¼" x 7'2¾"]	-	871	871	882	882	882
914 x 1981	[3'0" x 6'6"]	1044 x 2049 [3'4⅓" x 6'8¾"]	1035	1024	1024	1035	1035	1035
914 x 2134	[3'0" x 7'0"]	1044 x 2202 [3'4⅓" x 7'2¾"]	1035	1024	1024	1035	1035	1035
1219 x 1981	[4'0" x 6'6"]	1349 x 2049 [4'4⅓" x 6'8¾"]	1223	1129	1129	1223	1223	1223
1219 x 2134	[4'0" x 7'0"]	1349 x 2202 [4'4⅓" x 7'2¾"]	1223	1129	1129	1223	1223	1223

### Size availability (mm)

Minimum width	756	419	419	756	419	419
Maximum width	1067	1219	1219	1067	1219	1219
Minimum height	1864	1829	1829	1864	1829	1829
Maximum height	2134	2286	2286	2134	2286	2286

### Personnel doors - options

Painted frame	£29
Glazing (Brompton)	£127 (Stippled or Plain)
Glazing (Regal)	£127 (Stippled, Plain, Diamond Lattice, Square Lattice)

50mm frame available at no extra cost

Frames for Golden Oak finished doors are Clay Brown RAL 8003

Frames for Rosewood finished doors are Cherry - Master Chroma 3353

**Made to measure - take next size up and add £70**

## TIMBER SINGLE UP & OVER DOORS

### Cardale Timber Futura up & over single doors

#### Timber Futura up & over single doors

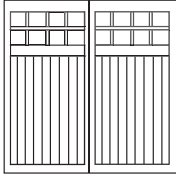
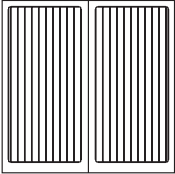
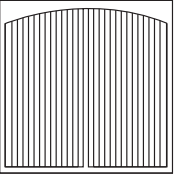
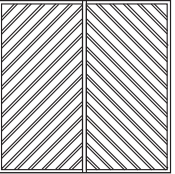
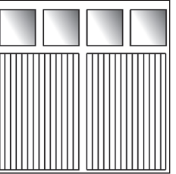
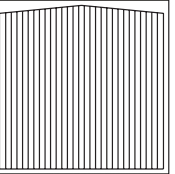
Size mm (ft/in) Width by Height												
	<b>Bedford</b>		<b>Berkeley Vertical</b>		<b>Burley</b>		<b>Chevron</b>		<b>Cotswold</b>		<b>Gatcombe</b>	
	C	R	C	R	C	R	C	R	C	R	C	R
2134 x 1981 (7'0" x 6'6")	2155	2219	1895	1959	1845	1909	2017	2081	1980	2044	1811	1875
2134 x 2134 (7'0" x 7'0")	2155	2219	1895	1959	1845	1909	2017	2081	1980	2044	1811	1875
2134 x 2286 (7'0" x 7'6")	-	2349	-	2087	-	2215	-	2210	-	2171	-	2002
2286 x 1981 (7'6" x 6'6")	2270	2335	1957	2021	1929	1994	2130	2195	2086	2150	1957	2021
2286 x 2134 (7'6" x 7'0")	2270	2335	1957	2021	1929	1994	2130	2195	2086	2150	1957	2021
2286 x 2286 (7'6" x 7'6")	-	2463	-	2150	-	2120	-	2321	-	2278	-	2150
2438 x 1981 (8'0" x 6'6")	2310	2374	2030	2094	1985	2049	2359	2423	2170	2234	2030	2094
2438 x 2134 (8'0" x 7'0")	2310	2374	2030	2094	1985	2049	2359	2423	2170	2234	2030	2094
2438 x 2286 (8'0" x 7'6")	-	2502	-	2220	-	2176	-	2551	-	2361	-	2220
2743 x 1981 (9'0" x 6'6")	-	-	-	2608	-	2438	-	-	-	2693	-	2450
2743 x 2134 (9'0" x 7'0")	-	-	-	2608	-	2438	-	-	-	2693	-	2450
3048 x 1981 (10'0" x 6'6")	-	-	-	2748	-	2536	-	-	-	2998	-	2527
3048 x 2134 (10'0" x 7'0")	-	-	-	2748	-	2536	-	-	-	2998	-	2527

Made to Measure doors add £174

#### Size availability (mm) for Made to Measure doors

Minimum width	1981	1981	1981	1981	1981	1981	1981	1981	1981	1981	1981	1981
Maximum width	2438	2438	2438	3048	2438	3048	2438	2438	2438	3048	2438	3048
Minimum height	1800	1829	1800	1829	1800	1829	1800	1829	1800	1829	1800	1829
Maximum height	2134	2286	2134	2286	2134	2286	2134	2286	2134	2286	2134	2286

C = Canopy gear, R = Retractable gear.

**All timber doors are bespoke and made to order.**

#### Timber up & over single doors - options

Standard frame	add £134 (Brown RAL 8017)
Coloured frame	
54mm/70mm	add £183 (Coloured paint)
Cardale DC650T operator	add £511
Cardale DC800T operator	add £663
Glazing (Bedford)	Stippled as standard
Glazing (Cotswold)	Plain black, Stippled, Transparent, Diamond lattice, Queen Anne lattice, Square lattice (Cotswold only at no extra cost)
Glazing (Ibstock & Strathmore)	Stippled as standard

#### Optional extras for operators

Extra handsets	add £76 (2 channel) add £85 (4 channel)
Wireless key pad	add £211
External manual override	add £48
Keypad	add £51

## Cardale Timber Futura up & over doors

### Timber Futura up & over single doors

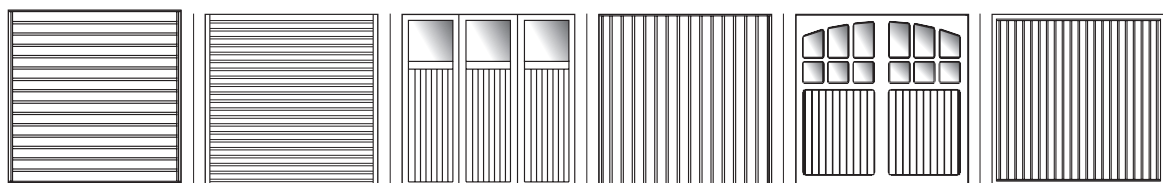

Size mm (ft/in) Width by Height	Hampshire		Horizontal		Ibstock		Kent Wide		Strathmore		Vertical	
	C	R	C	R	C	R	C	R	C	R	C	R
2134 x 1981 (7'0" x 6'6")	2336	2400	1675	1738	2332	2397	2336	2400	2352	2416	1659	1724
2134 x 2134 (7'0" x 7'0")	2336	2400	1675	1738	2332	2397	2336	2400	2352	2416	1659	1724
2134 x 2286 (7'0" x 7'6")	-	2526	-	1866	-	2523	-	2525	-	2544	-	1850
2286 x 1981 (7'6" x 6'6")	2513	2577	1783	1847	2804	2868	2513	2577	2656	2721	1769	1833
2286 x 2134 (7'6" x 7'0")	2513	2577	1783	1847	2804	2868	2513	2577	2656	2721	1769	1833
2286 x 2286 (7'6" x 7'6")	-	2704	-	1975	-	2996	-	3086	-	2912	-	1959
2438 x 1981 (8'0" x 6'6")	2664	2728	1877	1941	2487	2552	2664	2728	3087	3151	1863	1927
2438 x 2134 (8'0" x 7'0")	2664	2728	1877	1941	2487	2552	2664	2728	3087	3151	1863	1927
2438 x 2286 (8'0" x 7'6")	-	2856	-	2068	-	2679	-	2856	-	3279	-	2055
2743 x 1981 (9'0" x 6'6")	-	-	-	-	-	3238	-	3196	-	-	-	2446
2743 x 2134 (9'0" x 7'0")	-	-	-	-	-	3238	-	3196	-	-	-	2502
3048 x 1981 (10'0" x 6'6")	-	-	-	-	-	3612	-	3612	-	-	-	2506
3048 x 2134 (10'0" x 7'0")	-	-	-	-	-	3612	-	3612	-	-	-	2506

Made to Measure doors add £174

#### Size availability (mm) for Made to Measure doors

Minimum width	1981	1981	1981	1981	1981	1981	1981	1981	1981	1981	1981	1981
Maximum width	2438	2438	2438	2438	2438	3048	2438	3048	2438	2438	2438	3048
Minimum height	1800	1829	1800	1829	1829	1860	1829	1860	1829	1860	1829	1860
Maximum height	2134	2438	2134	2438	2134	2438	2134	2438	2134	2438	2134	2438

#### Timber door fully finished options

Cardale fully finished option is a factory finish process, the Sikkens product used is available in six attractive colours as below. For south facing situations exposed to strong sunlight the dark colours are not recommended, as they can store excessive heat and dry out. Timber doors are supplied with a basecoat stain as standard. They MUST be finished immediately after installation.

Fully finished single timber doors Add £167

#### Factory Finishes available:

Light Oak  
 Burnt Oak  
 Rosewood  
 Walnut  
 Mahogany  
 Ebony

RAL colours available Add £336

## TIMBER DOUBLE UP & OVER DOORS

### Cardale Timber Futura up & over double doors

#### Timber Futura up & over double doors

Size mm (ft/in)  
Width by Height

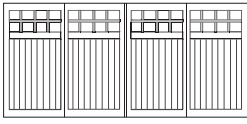
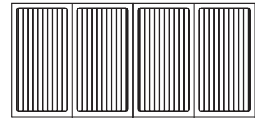
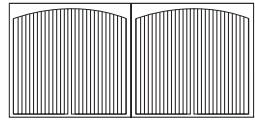
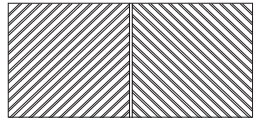
				
	<b>Bedford</b>	<b>Berkeley Vertical</b>	<b>Burley</b>	<b>Chevron</b>
	R	R	R	R
3048 x 2438 (10'0" x 8'0")	-	2915	2803	3568
3658 x 1981 (12'0" x 6'6")	-	3143	3184	3661
3658 x 2134 (12'0" x 7'0")	-	3143	3184	3661
3658 x 2438 (12'0" x 8'0")	-	3311	3487	3889
3962 x 1981 (13'0" x 6'6")	-	3126	3339	3822
3962 x 2134 (13'0" x 7'0")	-	3126	3339	3822
3962 x 2438 (13'0" x 8'0")	-	3375	3645	4105
4267 x 1981 (14'0" x 6'6")	4501	3423	3830	4367
4267 x 2134 (14'0" x 7'0")	4501	3423	3830	4367
4267 x 2438 (14'0" x 8'0")	4621	3776	4169	4731
4572 x 1981 (15'0" x 6'6")	4653	3663	4158	4587
4572 x 2134 (15'0" x 7'0")	4653	3663	4158	4587
4572 x 2438 (15'0" x 8'0")	5067	3936	4481	4924
4877 x 1981 (16'0" x 6'6")	5348	4272	4903	5265
4877 x 2134 (16'0" x 7'0")	5348	4272	4903	5265
4877 x 2438 (16'0" x 8'0")	5333	4398	5139	5504

Made to Measure doors add £258

#### Size availability (mm) for Made to Measure doors

Minimum width	2438	2438	2438	2438
Maximum width	4877	4877	4877	4877
Minimum height	1840	1840	1840	1840
Maximum height	2438	2438	2438	2438

R = Retractable gear.

#### Timber up & over double doors - options

Standard frame	add £238 (Brown RAL 8017)
Coloured frame 68mm	add £318 (Coloured paint)
Cardale DC650T operator	add £511
Cardale DC800T operator	add £663
Glazing (Bedford)	Stippled as standard
Glazing (Cotswold)	Plain black, Stippled, Transparent, Diamond lattice, Queen Anne lattice, Square lattice (Cotswold only at no extra cost)

**All timber doors are bespoke and made to order.**

Frames ordered with a double door will be supplied as a separate knocked down item.

#### Optional extras for operators

Extra handsets	add £77 (2 channel) add £85 (4 channel)
Wireless key pad	add £211
External manual override	add £48
Keyswitch	add £51

## Cardale Timber Futura up & over double doors

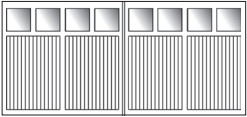
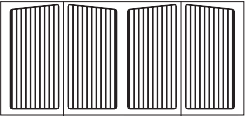
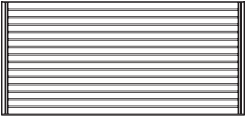
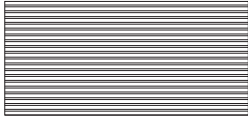
Timber Futura up & over double doors				
	Cotswold	Gatcombe	Hampshire	Horizontal
Size mm (ft/in) Width by Height	R	R	R	R
3048 x 2438 (10'0" x 8'0")	3067	2880	3469	2580
3658 x 1981 (12'0" x 6'6")	3633	3193	3704	2614
3658 x 2134 (12'0" x 7'0")	3633	3193	3704	2614
3658 x 2438 (12'0" x 8'0")	3734	3470	3831	2869
3962 x 1981 (13'0" x 6'6")	3971	3353	-	-
3962 x 2134 (13'0" x 7'0")	3971	3353	-	-
3962 x 2438 (13'0" x 8'0")	4046	3628	-	-
4267 x 1981 (14'0" x 6'6")	4259	3845	3832	2869
4267 x 2134 (14'0" x 7'0")	4259	3845	3832	2869
4267 x 2438 (14'0" x 8'0")	4494	4150	4089	3125
4572 x 1981 (15'0" x 6'6")	4659	4161	-	-
4572 x 2134 (15'0" x 7'0")	4659	4161	-	-
4572 x 2438 (15'0" x 8'0")	4806	4477	-	-
4877 x 1981 (16'0" x 6'6")	4912	4897	4175	3380
4877 x 2134 (16'0" x 7'0")	4912	4897	4175	3380
4877 x 2438 (16'0" x 8'0")	5331	5148	4345	3565

### Made to Measure doors add £258

#### Size availability (mm) for Made to Measure doors

Minimum width	2438	2438	2438	2438
Maximum width	4877	4877	4877	4877
Minimum height	1880	1880	1880	1880
Maximum height	2438	2438	2438	2438

### Timber door fully finished options

Cardale fully finished option is a factory finish process, the Sikkens product used is available in six attractive colours as below. For south facing situations exposed to strong sunlight the dark colours are not recommended, as they can store excessive heat and dry out. Timber doors are supplied with a basecoat stain as standard. They MUST be finished immediately after installation.

### Fully finished double timber doors Add £274

#### Factory Finishes available:

Light Oak  
Burnt Oak  
Rosewood  
Walnut  
Mahogany  
Ebony

RAL colours available      Add £550

Frames ordered with a double door will be supplied as a separate knocked down item.

## TIMBER DOUBLE UP & OVER DOORS

### Cardale Timber Futura up & over double doors

#### Timber Futura up & over double doors

Size mm (ft/in)  
Width by Height

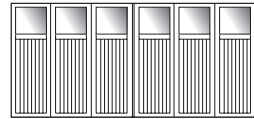

Ibstock

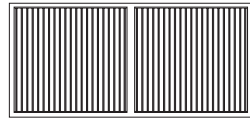

Kent Wide

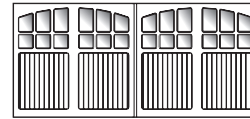

Strathmore

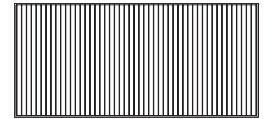

Vertical

	R	R	R	R
3048 x 2438 (10'0" x 8'0")	3707	3707	-	2601
3658 x 1981 (12'0" x 6'6")	4225	4225	-	3264
3658 x 2134 (12'0" x 7'0")	4225	4225	-	3264
3658 x 2438 (12'0" x 8'0")	4322	4322	-	3380
3962 x 1981 (13'0" x 6'6")	4427	4427	-	3190
3962 x 2134 (13'0" x 7'0")	4427	4427	-	3190
3962 x 2438 (13'0" x 8'0")	4531	4531	-	3388
4267 x 1981 (14'0" x 6'6")	5071	5071	4616	3435
4267 x 2134 (14'0" x 7'0")	5071	5071	4616	3435
4267 x 2438 (14'0" x 8'0")	5194	5194	5281	3736
4572 x 1981 (15'0" x 6'6")	5230	5230	5364	3579
4572 x 2134 (15'0" x 7'0")	5230	5230	5364	3579
4572 x 2438 (15'0" x 8'0")	5330	5330	5502	3849
4877 x 1981 (16'0" x 6'6")	5915	5915	5843	4083
4877 x 2134 (16'0" x 7'0")	5915	5915	5843	4083
4877 x 2438 (16'0" x 8'0")	5885	5885	6149	4263

Made to Measure doors add £258

#### Size availability (mm) for Made to Measure doors

Minimum width	2438	2438	2438	2438
Maximum width	4877	4877	4877	4877
Minimum height	1880	1880	1880	1880
Maximum height	2438	2438	2438	2438

C = Canopy gear, R = Retractable gear.

#### Timber up & over double doors - options

Standard frame	add £238 (Brown RAL 8017)
Coloured frame 68mm	add £318 (Coloured paint)
Cardale DC650T operator	add £511
Cardale DC800T operator	add £663
Glazing (Ibstock and Strathmore)	Stippled as standard

#### Optional extras for operators

Extra handsets	add £77 (2 channel) add £85 (4 channel)
Wireless key pad	add £211
External manual override	add £48
Keyswitch	add £51

#### Timber door fully finished options

Cardale fully finished option is a factory finish process, the Sikkens product used is available in six attractive colours as below. For south facing situations exposed to strong sunlight the dark colours are not recommended, as they can store excessive heat and dry out. Timber doors are supplied with a basecoat stain as standard.

They MUST be finished immediately after installation.

#### Fully finished double timber doors Add £274

#### Factory Finishes available:

Light Oak  
Burnt Oak  
Rosewood  
Walnut  
Mahogany  
Ebony

RAL colours available Add £336

Frames ordered with a double door will be supplied as a separate knocked down item.

**All timber doors are bespoke and made to order.**

## TIMBER SINGLE UP & OVER DOORS

### Cardale Timber Heritage up & over single doors

#### Timber Heritage up & over single doors

Size mm (ft/in)  
Width by Height

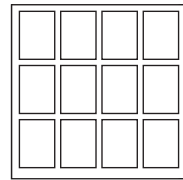

**Bromley**

C R

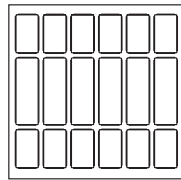

**Cardinal**

C R

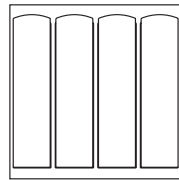

**Chiltern**

C R

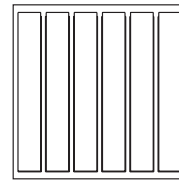

**Countryman**

C R

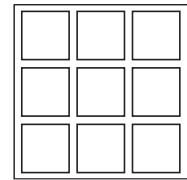

**Guildford**

C R

2134 x 1981	(7'0" x 6'6")	1761	1825	1670	1733	1670	1733	1670	1733	1761	1825
2134 x 2134	(7'0" x 7'0")	1761	1825	1670	1733	1670	1733	1670	1733	1761	1825
2134 x 2286	(7'0" x 7'6")	-	1850	-	1811	-	1811	-	1811	-	1850
2286 x 1981	(7'6" x 6'6")	1863	1928	1707	1772	1707	1772	1707	1772	1863	1928
2286 x 2134	(7'6" x 7'0")	1863	1928	1707	1772	1707	1772	1707	1772	1863	1928
2286 x 2286	(7'6" x 7'6")	-	1966	-	1931	-	1931	-	1931	-	1966
2438 x 1981	(8'0" x 6'6")	2106	2170	1834	1897	1834	1897	1834	1897	2031	2095
2438 x 2134	(8'0" x 7'0")	2106	2170	1834	1897	1834	1897	1834	1897	2031	2095
2438 x 2286	(8'0" x 7'6")	-	2297	-	2027	-	2027	-	2027	-	2221
2743 x 1981	(9'0" x 6'6")	-	2591	-	2307	-	2307	-	2307	-	2591
2743 x 2134	(9'0" x 7'0")	-	2591	-	2307	-	2307	-	2307	-	2591
3048 x 1981	(10'0" x 6'6")	-	2893	-	2491	-	2491	-	2491	-	2893
3048 x 2134	(10'0" x 7'0")	-	2893	-	2491	-	2491	-	2491	-	2893

Made to Measure doors add £258

#### Size availability (mm) for Made to Measure doors

Minimum width	1981	1981	1981	1981	1981	1981	1981	1981	1981	1981
Maximum width	2438	3048	2438	3048	2438	3048	2438	3048	2438	3048
Minimum height	1829	1860	1829	1860	1829	1860	1829	1860	1829	1860
Maximum height	2134	2286	2134	2286	2134	2286	2134	2286	2134	2286

C = Canopy gear, R = Retractable gear.

#### Timber up & over single doors - options

Standard frame	add £133 (Brown RAL 8017)
Coloured frame 54mm/70mm	add £182 (Coloured paint)
Cardale DC650T operator	add £511
Cardale DC800T operator	add £663
Glazing (Shropshire)	add £259 (Stippled as standard)

#### Optional extras for operators

Extra handsets	add £77 (2 channel) add £85 (4 channel)
Wireless key pad	add £211
External manual override	add £48
Keypad	add £51

#### Timber door fully finished options

Cardale fully finished option is a factory finish process, the Sikkens product used is available in six attractive colours as below. For south facing situations exposed to strong sunlight the dark colours are not recommended, as they can store excessive heat and dry out. Timber doors are supplied with a basecoat stain as standard. They MUST be finished immediately after installation.

#### Fully finished single timber doors Add £167

#### Factory Finishes available:

Light Oak  
Burnt Oak  
Rosewood  
Walnut  
Mahogany  
Ebony

RAL colours available Add £336

**All timber doors are bespoke and made to order.**

## TIMBER SINGLE UP & OVER DOORS

### Cardale Timber Heritage up & over single doors

#### Timber heritage up & over single doors

Size mm (ft/in)  
Width by Height

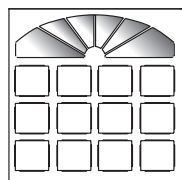

**Hampstead**  
C R

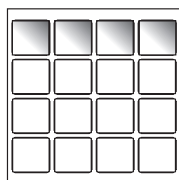

**Hathaway**  
C R

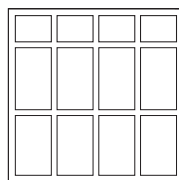

**Shropshire**  
C R

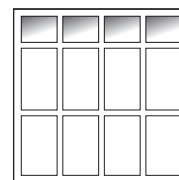

**Shropshire glazed**  
C R

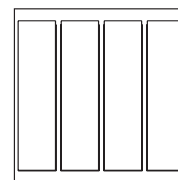

**Stuart**  
C R

Size mm (ft/in)	Width	Height	Hampstead C	Hampstead R	Hathaway C	Hathaway R	Shropshire C	Shropshire R	Shropshire glazed C	Shropshire glazed R	Stuart C	Stuart R
2134 x 1981	[7'0" x 6'6"]		2086	2150	2086	2150	1761	1825	1810	1874	1582	1646
2134 x 2134	[7'0" x 7'0"]		2086	2150	2086	2150	1761	1825	1810	1874	1582	1646
2134 x 2286	[7'0" x 7'6"]		-	2272	-	2272	-	1850	-	1910	-	1675
2286 x 1981	[7'6" x 6'6"]		2386	2450	2386	2450	1863	1929	1919	1983	1652	1715
2286 x 2134	[7'6" x 7'0"]		2386	2450	2386	2450	1863	1929	1919	1983	1652	1715
2286 x 2286	[7'6" x 7'6"]		-	2502	-	2502	-	1966	-	2011	-	1817
2438 x 1981	[8'0" x 6'6"]		2614	2678	2614	2678	2031	2095	2074	2138	1730	1793
2438 x 2134	[8'0" x 7'0"]		2614	2678	2614	2678	2031	2095	2074	2138	1730	1793
2438 x 2286	[8'0" x 7'6"]		-	2805	-	2805	-	2221	-	2264	-	1921
2743 x 1981	[9'0" x 6'6"]		-	-	-	3056	-	2591	-	2693	-	2191
2743 x 2134	[9'0" x 7'0"]		-	-	-	3056	-	2591	-	2693	-	2191
3048 x 1981	[10'0" x 6'6"]		-	-	-	3425	-	2893	-	2994	-	2391
3048 x 2134	[10'0" x 7'0"]		-	-	-	3425	-	2893	-	2994	-	2391

#### Made to Measure doors add £174

#### Size availability (mm) for Made to Measure doors

	1981	1981	1981	1981	1981	1981	1981	1981	1981	1981
Minimum width	1981	1981	1981	1981	1981	1981	1981	1981	1981	1981
Maximum width	2438	2438	2438	3048	2438	3048	2438	3048	2438	3048
Minimum height	1829	1860	1829	1860	1829	1860	1829	1860	1829	1860
Maximum height	2134	2286	2134	2286	2134	2286	2134	2286	2134	2286

C = Canopy gear, R = Retractable gear.

#### Timber up & over single doors - options

Standard frame	add £134 (Brown RAL 8017)
Coloured frame 54mm/70mm	add £183 (Coloured paint)
Cardale DC650T operator	add £511
Cardale DC800T operator	add £663
Glazing (Shropshire)	add £254 (Stippled as standard)

#### Optional extras for operators

Extra handsets	add £77 (2 channel) add £85 (4 channel)
Wireless key pad	add £211
External manual override	add £48
Keypad	add £51

#### Timber door fully finished options

Cardale fully finished option is a factory finish process, the Sikkens product used is available in six attractive colours as below. For south facing situations exposed to strong sunlight the dark colours are not recommended, as they can store excessive heat and dry out. Timber doors are supplied with a basecoat stain as standard. They MUST be finished immediately after installation.

#### Fully finished single timber doors Add £167

#### Factory Finishes available:

Light Oak  
Burnt Oak  
Rosewood  
Walnut  
Mahogany  
Ebony  
RAL colours available      Add £336

**All Timber doors are bespoke and made to order.**

## Cardale Timber Heritage up & over single doors

### Timber heritage up & over single doors

Size mm (ft/in)  
Width by Height

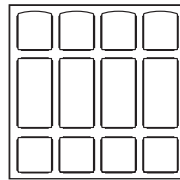

**Thornley**

C

R

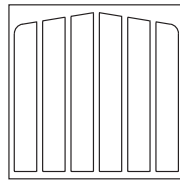

**Tudor**

C

R

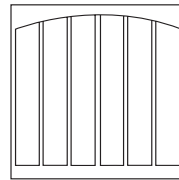

**Windsor**

C

R

2134 x 1981	(7'0" x 6'6")	2086	2150	1662	1725	1632	1696
2134 x 2134	(7'0" x 7'0")	2086	2150	1662	1725	1632	1696
2134 x 2286	(7'0" x 7'6")	2107	2272	-	-	-	1777
2286 x 1981	(7'6" x 6'6")	2386	2450	1734	1798	1512	1575
2286 x 2134	(7'6" x 7'0")	2386	2450	1734	1798	1512	1575
2286 x 2286	(7'6" x 7'6")	-	2502	-	-	-	1659
2438 x 1981	(8'0" x 6'6")	2614	2678	1816	1878	1526	1591
2438 x 2134	(8'0" x 7'0")	2614	2678	1816	1878	1526	1591
2438 x 2286	(8'0" x 7'6")	-	2805	-	2006	-	1720
2743 x 1981	(9'0" x 6'6")	-	2591	-	2307	-	2307
2743 x 2134	(9'0" x 7'0")	-	2591	-	2307	-	2307
3048 x 1981	(10'0" x 6'6")	-	2893	-	2491	-	2491
3048 x 2134	(10'0" x 7'0")	-	2893	-	2491	-	2491

### Made to Measure doors add £174

#### Size availability (mm) for Made to Measure doors

Minimum width	1981	1981	1981	1981	1981	1981
Maximum width	2438	3048	2438	3048	2438	3048
Minimum height	1829	1860	1829	1860	1829	1860
Maximum height	2134	2286	2134	2286	2134	22286

## TIMBER DOUBLE UP & OVER DOORS

### Cardale Timber Heritage up & over double doors

#### Timber Heritage up & over double doors

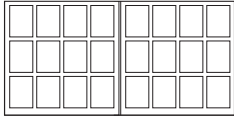
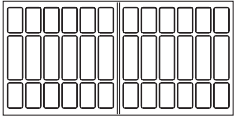
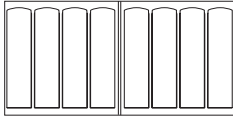
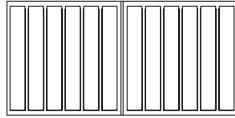
Size mm (ft/in) Width by Height				
	<b>Bromley</b>	<b>Cardinal</b>	<b>Chiltern</b>	<b>Countryman</b>
	R	R	R	R
3048 x 2438 (10'0" x 8'0")	3056	2774	2774	2774
3658 x 1981 (12'0" x 6'6")	3577	3013	3013	3013
3658 x 2134 (12'0" x 7'0")	3577	3013	3013	3013
3658 x 2438 (12'0" x 8'0")	3776	3212	3212	3212
4267 x 1981 (14'0" x 6'6")	4084	3502	3502	3502
4267 x 2134 (14'0" x 7'0")	4084	3502	3502	3502
4267 x 2438 (14'0" x 8'0")	2862	3710	3710	3710
4877 x 1981 (16'0" x 6'6")	4549	4411	4411	4411
4877 x 2134 (16'0" x 7'0")	4549	4411	4411	4411
4877 x 2438 (16'0" x 8'0")	4727	4590	4590	4590

Made to Measure doors add £258

#### Size availability (mm) for Made to Measure doors

Minimum width	2438	2438	2438	2438
Maximum width	4877	4877	4877	4877
Minimum height	1880	1880	1880	1880
Maximum height	2438	2438	2438	2438

C = Canopy gear, R = Retractable gear.

#### Timber up & over double doors - options

Standard frame	add £238 (Brown RAL 8017)
Coloured frame 68mm	add £318 (Coloured paint)
Cardale DC650T operator	add £511
Cardale DC800T operator	add £663
Glazing (Bromley, Shropshire, Guildford)	add £522 (Stippled as standard)

#### Optional extras for operators

Extra handsets	add £77 (2 channel) add £85 (4 channel)
Wireless key pad	add £211
External manual override	add £48
Keypad	add £51

**All timber doors are bespoke and made to order.**

Frames ordered with a double door will be supplied as a separate knocked down item.

## Cardale Timber Heritage up & over double doors

### Timber Heritage up & over double doors

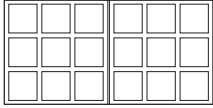
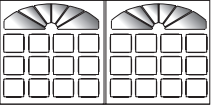
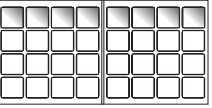
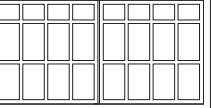
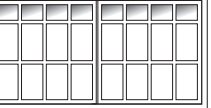
Size mm (ft/in) Width by Height					
	<b>Guildford</b>	<b>Hampstead</b>	<b>Hathaway</b>	<b>Shropshire</b>	<b>Shropshire glazed</b>
	R	R	R	R	R
3048 x (10'0" x 8'0")	3056	-	3707	3056	3158
3658 x (12'0" x 6'6")	3577	-	3638	3577	3679
3658 x (12'0" x 7'0")	3577	-	3638	3577	3679
3658 x (12'0" x 8'0")	3776	-	3902	3776	3877
4267 x (14'0" x 6'6")	4084	4930	4536	4084	4186
4267 x (14'0" x 7'0")	4084	4930	4536	4084	4186
4267 x (14'0" x 8'0")	5256	5255	4862	4273	4375
4877 x (16'0" x 6'6")	4549	5482	5087	4549	4652
4877 x (16'0" x 7'0")	4549	5482	5087	4549	4652
4877 x (16'0" x 8'0")	4727	5856	5460	4727	4830

**Made to Measure doors add £258**

#### Size availability (mm) for Made to Measure doors

Minimum width	2438	2438	2438	2438	2438
Maximum width	4877	4877	4877	4877	4877
Minimum height	1880	1880	1880	1880	1880
Maximum height	2438	2438	2438	2438	2438

#### Timber door fully finished options

Cardale fully finished option is a factory finish process, the Sikkens product used is available in six attractive colours as below. For south facing situations exposed to strong sunlight the dark colours are not recommended, as they can store excessive heat and dry out. Timber doors are supplied with a basecoat stain as standard. They MUST be finished immediately after installation.

#### Fully finished double timber doors Add £274

#### Factory Finishes available:

Light Oak  
Burnt Oak  
Rosewood  
Walnut  
Mahogany  
Ebony

RAL colours available      Add £550

Frames ordered with a double door will be supplied as a separate knocked down item.

## TIMBER DOUBLE UP & OVER DOORS

### Cardale Timber Heritage up & over double doors

#### Timber Heritage up & over double doors

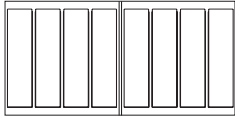
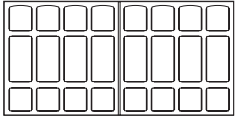
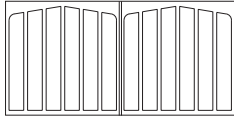
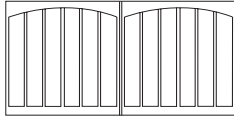
Size mm (ft/in) Width by Height				
	Stuart R	Thornley R	Tudor R	Windsor R
3048 x 2438 (10'0" x 8'0")	2575	3056	2774	2774
3658 x 1981 (12'0" x 6'6")	2914	3577	3013	3013
3658 x 2134 (12'0" x 7'0")	2914	3577	3013	3013
3658 x 2438 (12'0" x 8'0")	3085	3776	3212	3212
4267 x 1981 (14'0" x 6'6")	2974	4084	3502	3502
4267 x 2134 (14'0" x 7'0")	2974	4084	3502	3502
4267 x 2438 (14'0" x 8'0")	3311	4272	3710	3710
4877 x 1981 (16'0" x 6'6")	4327	4549	4411	4411
4877 x 2134 (16'0" x 7'0")	4327	4549	4411	4411
4877 x 2438 (16'0" x 8'0")	4509	4727	4590	4590

Made to Measure doors add £166

#### Size availability (mm) for Made to Measure doors

Minimum width	2438	2438	2438	2438
Maximum width	4877	4877	4877	4877
Minimum height	1880	1880	1880	1880
Maximum height	2438	2438	2438	2438

C = Canopy gear, R = Retractable gear.

#### Timber up & over double doors - options

Standard frame	add £238 (Brown RAL 8017)
Coloured frame 68mm	add £318 (Coloured paint)
Cardale DC650T operator	add £511
Cardale DC800T operator	add £663

#### Timber door fully finished options

Cardale fully finished option is a factory finish process, the Sikkens product used is available in six attractive colours as below. For south facing situations exposed to strong sunlight the dark colours are not recommended, as they can store excessive heat and dry out. Timber doors are supplied with a basecoat stain as standard. They MUST be finished immediately after installation.

#### Fully finished double timber doors Add £274

#### Factory Finishes available:

Light Oak  
Burnt Oak  
Rosewood  
Walnut  
Mahogany  
Ebony

RAL colours available Add £550

Frames ordered with a double door will be supplied as a separate knocked down item.

#### Optional extras for operators

Extra handsets	add £77 (2 channel) add £85 (4 channel)
Wireless key pad	add £211
External manual override	add £48
Keyswitch	add £51

#### All timber doors are bespoke and made to order.

Frames ordered with a double door will be supplied as a separate knocked down item.

# TIMBER SECURED BY DESIGN DOORS

## Cardale Secured by Design Timber single doors

### Secured by Design steel single doors

Size mm (ft/in)  
Width by Height

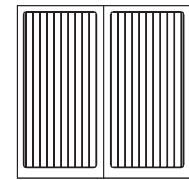

**Berkeley Vertical**  
R

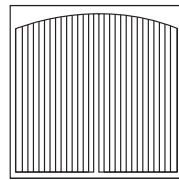

**Burley**  
R

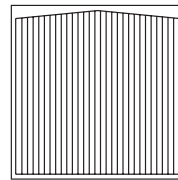

**Gatcombe**  
R

Size mm (ft/in) Width by Height	Berkeley Vertical R	Burley R	Gatcombe R
1981 x 1830 6'6" x 6'0"	2924	2858	2800
1981 x 1905 6'6" x 6'3"	2924	2858	2800
1981 x 1930 6'6" x 6'4"	2924	2858	2800
1981 x 1981 6'6" x 6'6"	2924	2858	2800
2085 x 1930 6'10" x 6'4"	2924	2858	2800
2085 x 1981 6'10" x 6'6"	2924	2858	2800
2085 x 2134 6'10" x 7'0"	2924	2858	2800
2083 x 2210 6'10" x 7'3"	2924	2858	2800
2083 x 2286 6'10" x 7'6"	2924	2858	2800
2134 x 1830 7'0" x 6'0"	2924	2858	2800
2134 x 1905 7'0" x 6'3"	2924	2858	2800
2134 x 1930 7'0" x 6'4"	2924	2858	2800
2134 x 1981 7'0" x 6'6"	2924	2858	2800
2134 x 2134 7'0" x 7'0"	2924	2865	2814
2134 x 2210 7'0" x 7'3"	2924	2865	2814
2134 x 2286 7'0" x 7'6"	2924	3322	3005
2225 x 1930 7'3" x 6'4"	2924	3322	3005
2225 x 1981 7'3" x 6'6"	2924	3322	3005
2225 x 2134 7'3" x 7'0"	2924	3322	3005
2210 x 2210 7'3" x 7'3"	2924	3322	3005
2210 x 2286 7'3" x 7'6"	2924	3322	3005
2260 x 1930 7'5" x 6'4"	2924	3322	3005
2260 x 1981 7'5" x 6'6"	2924	3322	3005
2260 x 2134 7'5" x 7'0"	2924	3322	3005
2261 x 2210 7'5" x 7'3"	2924	3322	3005
2261 x 2286 7'5" x 7'6"	2924	3322	3005
2285 x 1930 7'6" x 6'4"	2940	3322	3005
2285 x 1981 7'6" x 6'6"	2940	2928	3010
2285 x 2134 7'6" x 7'0"	2940	2989	3033
2286 x 2210 7'6" x 7'3"	2940	2989	3033
2286 x 2286 7'6" x 7'6"	3131	3180	3224
2438 x 1930 8'0" x 6'4"	3131	3180	3224
2438 x 1981 8'0" x 6'6"	3131	3009	3134
2438 x 2134 8'0" x 7'0"	3131	3074	3141
2438 x 2210 8'0" x 7'3"	3131	3074	3141
2438 x 2286 8'0" x 7'6"	3131	3266	3332

Cardale Secured by Design garage doors have spring assisted retractable action for smooth running.

Factory fitted steel frames as standard 70mm wide. Cardale Secured by Design Up & Over garage doors can only be supplied in a pre-hung factory finished steel fixing frame, which makes installation simple and eliminates the need for a timber frame. These frames are supplied as standard in white, however colour matched frames are also available. Supplied with our black "D" handle.

## Secured by Design



### Official Police Security Initiative

Cardale Secured by Design doors are certificated to CS 5051 STS202 which is approved by ACPO Association Of Chief Police Officers.

### Secured by Design doors - options

Matching coloured frame add £171  
Painted door panel add £119 (Colours)

### Optional extras for operators

Extra handsets add £77 (2 channel)  
add £85 (4 channel)  
Wireless key pad add £211  
External manual override add £6  
Keypad add £51

R = Retractable gear, C = Canopy

**Canopy and retractable doors are the same price**

### Factory Finishes available:

Light Oak  
Burnt Oak  
Rosewood  
Walnut  
Mahogany  
Ebony

RAL colours available add £320

**Secured by Design doors are bespoke and made to order.**

## TIMBER SIDE HINGED DOORS

### Cardale Timber Futura side hinged doors

#### Timber Futura side hinged single doors

Size mm (ft/in)  
Width by Height

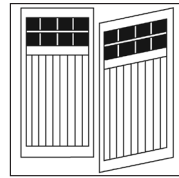

**Bedford**  
(1/2 - 1/2)

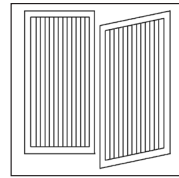

**Berkeley Vertical**  
(1/2 - 1/2)

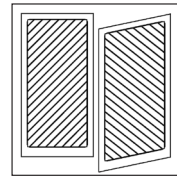

**Chevron**  
(1/2 - 1/2)

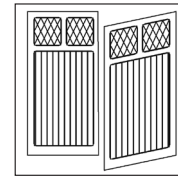

**Garage Light**  
(1/2 - 1/2)

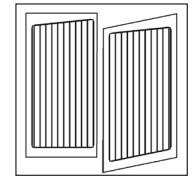

**Gatcombe**  
(1/2 - 1/2)

2134 x 1981	(7'0" x 6'6")	2474	2278	2291	2474	2278
2134 x 2134	(7'0" x 7'0")	2515	2291	2313	2515	2291
2286 x 1981	(7'6" x 6'6")	2653	2350	2438	2653	2350
2286 x 2134	(7'6" x 7'0")	2745	2393	2504	2745	2393
2438 x 1981	(8'0" x 6'6")	2835	2512	2614	2835	2512
2438 x 2134	(8'0" x 7'0")	2881	2571	2669	2881	2571

**Made to Measure doors add £174**

#### Size availability (mm) for Made to Measure doors

Minimum width	1778	1778	1778	1778	1778
Maximum width	2438	2438	2438	2438	2438
Minimum height	1775	1775	1775	1775	1775
Maximum height	2286	2286	2286	2286	2286

#### Timber side hinged doors - options

Fully finished add £165

Unframed deduct £41

Painted frame add £29

Left hand opening add £78

Glazing (Bedford, Garage Light, Ibstock) Stippled as standard

Glazing (Milton) add £141 (Stippled, as standard)

Side hinged doors supplied with pre-finished conker brown 50mm frame as standard.

Doors supplied as standard right hand opening when viewed from outside.

All side hinged doors open outwards.

#### Timber door fully finished options

Cardale fully finished option is a factory finish process, the Sikkens product used is available in six attractive colours as below. For south facing situations exposed to strong sunlight the dark colours are not recommended, as they can store excessive heat and dry out. Timber doors are supplied with a basecoat stain as standard.

They MUST be finished immediately after installation.

**Fully finished double timber doors Add £274**

**Made to measure doors Add £169**

#### Factory Finishes available:

Light Oak  
Burnt Oak  
Rosewood  
Walnut  
Mahogany  
Ebony

RAL colours are available add £331

## Cardale Timber Futura side hinged doors

### Timber Futura side hinged single doors

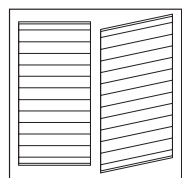

**Hampshire**  
(1/2 - 1/2)

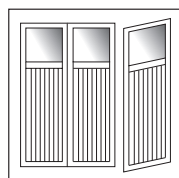

**Ibstock**  
(1/2 - 1/2)

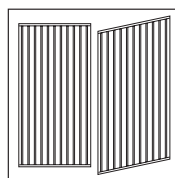

**Kent**  
(1/2 - 1/2)

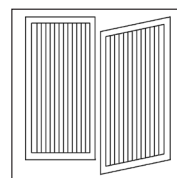

**Vertical**  
(1/2 - 1/2)

Size mm (ft/in)  
Width by Height

Size mm (ft/in)	Width by Height	Hampshire (1/2 - 1/2)	Ibstock (1/2 - 1/2)	Kent (1/2 - 1/2)	Vertical (1/2 - 1/2)
2134 x 1981	(7'0" x 6'6")	2578	2629	2578	2149
2134 x 2134	(7'0" x 7'0")	2607	2659	2607	2173
2286 x 1981	(7'6" x 6'6")	2650	2809	2650	2208
2286 x 2134	(7'6" x 7'0")	2701	2887	2701	2251
2438 x 1981	(8'0" x 6'6")	2845	2998	2845	2370
2438 x 2134	(8'0" x 7'0")	2916	3036	2916	2431

**Made to Measure doors add £174**

#### Size availability (mm) for Made to Measure doors

Minimum width	1778	1778	1778	1778
Maximum width	2438	2438	2438	2438
Minimum height	1775	1775	1775	1775
Maximum height	2286	2286	2286	2286

**All side hinged doors come complete with door stay.**

**All side hinged doors are bespoke and made to order.**

The standard handle pack includes a Cardale handle and a Black lever handle.

All doors are supplied as standard with 1 pair of door stays.  
Top and bottom shoot bolts.

Chassis and fixing frames are supplied in Brown  
RAL 8017 as standard.

## TIMBER SIDE HINGED DOORS

### Cardale Timber Heritage side hinged doors

#### Timber Heritage side hinged single doors

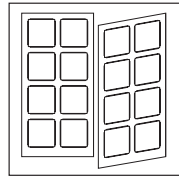

**Malvern**  
(1/2 - 1/2)

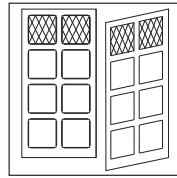

**Milton**  
(1/2 - 1/2)

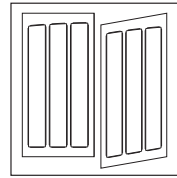

**Rutland**  
(1/2 - 1/2)

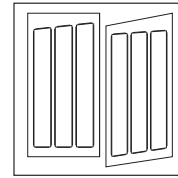

**Shakespeare**  
(1/2 - 1/2)

Size mm (ft/in) Width by Height		Malvern (1/2 - 1/2)	Milton (1/2 - 1/2)	Rutland (1/2 - 1/2)	Shakespeare (1/2 - 1/2)
2134 x 1981 (7'0" x 6'6")		2114	2120	2015	2015
2134 x 2134 (7'0" x 7'0")		2152	2158	2052	2052
2286 x 1981 (7'6" x 6'6")		2183	2188	2082	2082
2286 x 2134 (7'6" x 7'0")		2211	2217	2111	2111
2438 x 1981 (8'0" x 6'6")		2351	2357	2251	2251
2438 x 2134 (8'0" x 7'0")		2418	2424	2319	2319

**Made to Measure doors add £174**

#### Size availability (mm) for Made to Measure doors

Minimum width	1778	1778	1778	1778
Maximum width	2438	2438	2438	2438
Minimum height	1775	1775	1775	1775
Maximum height	2286	2286	2286	2286

**All side hinged doors come complete with door stay.**

**All side hinged doors are bespoke and made to**

#### Timber side hinged doors - options

Fully finished	add £165
Unframed	deduct £41
Painted frame	add £29
Left hand opening	add £84
Glazing (Bedford, Garage Light, Ibstock)	Stippled as standard
Glazing (Milton)	add £141 (Stippled, as standard)

Side hinged doors supplied with pre-finished conker brown 50mm frame as standard.

Doors supplied as standard right hand opening when viewed from outside.

All side hinged doors open outwards.

**All side hinged doors come complete with door stay.**

**All side hinged doors are bespoke and made to order.**

The standard handle pack includes a Cardale handle and a Black lever handle.

All doors are supplied as standard with 1 pair of door stays. Top and bottom shoot bolts.

Chassis and fixing frames are supplied in Brown RAL 8017 as standard.

#### Timber door fully finished options

Cardale fully finished option is a factory finish process, the Sikkens product used is available in six attractive colours as below. For south facing situations exposed to strong sunlight the dark colours are not recommended, as they can store excessive heat and dry out. Timber doors are supplied with a basecoat stain as standard.

They MUST be finished immediately after installation.

#### Fully finished double timber doors Add £274

#### Factory Finishes available:

Light Oak  
Burnt Oak  
Rosewood  
Walnut  
Mahogany  
Ebony

RAL colours are available add £331

## Cardale GRP single doors

### GRP single doors

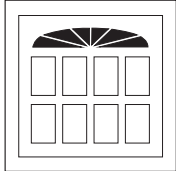
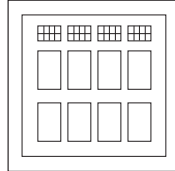
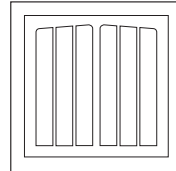
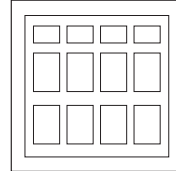
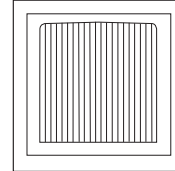
Size mm (ft/in) Width by Height										
	C	R	C	R	C	R	C	R	C	R
2134 x 1981 (7'0" x 6'6")	2014	2078	1742	1807	1973	2037	1973	2037	1973	2037
2134 x 2134 (7'0" x 7'0")	2014	2078	1742	1807	1973	2037	1973	2037	1973	2037
2286 x 1981 (7'5" x 6'6")	2213	2277	1844	1908	2270	2335	2270	2335	2270	2335
2286 x 2134 (7'5" x 7'0")	2213	2277	1844	1908	2270	2335	2270	2335	2270	2335
2286 x 1981 (7'6" x 6'6")	2213	2277	1844	1908	2270	2335	2270	2335	2270	2335
2286 x 2134 (7'6" x 7'0")	2213	2277	1844	1908	2270	2335	2270	2335	2270	2335
2438 x 1981 (8'0" x 6'6")	2289	2353	1919	1983	2344	2408	2344	2408	2344	2408
2438 x 2134 (8'0" x 7'0")	2289	2353	1919	1983	2344	2408	2344	2408	2344	2408

#### Size availability (mm) for Made to Measure doors

Minimum width	2032	2032	2032	2032	2032	2032	2032	2032	1981	1981
Maximum width	2438	2438	2540	2540	2438	2438	2438	2438	2380	2380
Minimum height	1880	1880	1880	1880	1880	1880	1880	1880	1981	1981
Maximum height	2134	2134	2286	2286	2134	2134	2286	2286	2134	2134

### GRP single doors

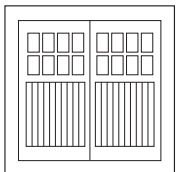
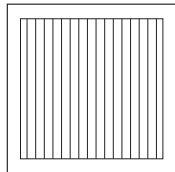
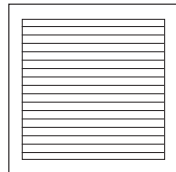
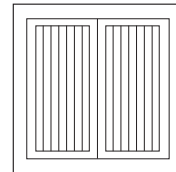
Size mm (ft/in) Width by Height								
	C	R	C	R	C	R	C	R
2134 x 1981 (7'0" x 6'6")	2342	2406	1973	2037	1973	2037	1973	2037
2134 x 2134 (7'0" x 7'0")	2342	2406	1973	2037	1973	2037	1973	2037
2286 x 1981 (7'5" x 6'6")	2398	2462	2270	2335	2270	2335	2270	2335
2286 x 2134 (7'5" x 7'0")	2398	2462	2270	2335	2270	2335	2270	2335
2286 x 1981 (7'6" x 6'6")	2398	2462	2270	2335	2270	2335	2270	2335
2286 x 2134 (7'6" x 7'0")	2398	2462	2270	2335	2270	2335	2270	2335
2438 x 1981 (8'0" x 6'6")	2469	2533	2344	2408	2344	2408	2344	2408
2438 x 2134 (8'0" x 7'0")	2469	2533	2344	2408	2344	2408	2344	2408

#### Size availability (mm) for Made to Measure doors

Minimum width	2134	2134	1981	1981	1981	1981	2134	2134
Maximum width	2438	2438	2438	2438	2286	2286	2540	2540
Minimum height	1931	1931	1829	1829	1829	1829	1981	2032
Maximum height	2134	2134	2286	2286	2438	2438	2286	2286

C = Canopy gear, R = Retractable gear.

#### GRP single doors - options

Standard frame	£134 (Pre-finished or white painted)
Coloured frame	£182 (Coloured paint)
Glazing (Lyndhurst II)	£184 (Stippled) Black mock glazing standard
Glazing (Sutherland) standard	£291 (Stippled or plain) Black mock glazing standard
Glazing (Georgian II)	Plain black, Stippled, Transparent, Diamond lattice, Queen Anne lattice, Square lattice (add £281)
Glazing (Chelsea II)	£312

#### Woodgrain colour options standard as price list

White, Magnolia, Bleached Oak, Red Mahogany, Light Oak, Dark Oak, Honey Beech, Teak, Rosewood, Dark Mahogany Golden Brown, Ebony, Irish Oak, Ageta Grey, Anthracite Grey

#### Woodgrain colour options at additional cost

Blue, Red, Green £256  
RAL colour of your choice £320

#### High Gloss colour options standard as price list

Gloss White and Gloss Magnolia

**All GRP doors are bespoke and made to order.**

## Cardale GRP double doors

### GRP double doors

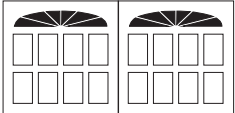
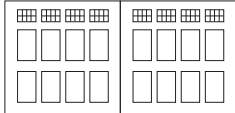
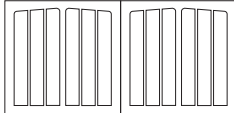
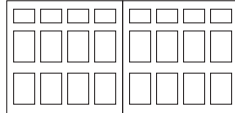
Size mm (ft/in) Width by Height				
	Chelsea II glasswhite	Georgian II glasswhite	Hambleton II glasswood	Lyndhurst II glasswood
	R	R	R	R
2743 x 1981 (9'0" x 6'6")	-	2562	-	2778
2743 x 2134 (9'0" x 7'0")	-	2562	-	2778
3048 x 1981 (10'0" x 6'6")	-	2802	-	3020
3048 x 2134 (10'0" x 7'0")	-	2802	-	3020
3353 x 1981 (11'0" x 6'6")	-	3131	-	3313
3353 x 2134 (11'0" x 7'0")	-	3131	-	3313
3658 x 1981 (12'0" x 6'6")	-	3375	-	3702
3658 x 2134 (12'0" x 7'0")	-	3375	-	3702
3962 x 1981 (13'0" x 6'6")	-	3437	-	3827
3962 x 2134 (13'0" x 7'0")	-	3437	-	3827
4267 x 1981 (14'0" x 6'6")	3711	3367	3866	3866
4267 x 2134 (14'0" x 7'0")	3711	3367	3866	3866
4572 x 1981 (15'0" x 6'6")	4326	3987	4425	4425
4572 x 2134 (15'0" x 7'0")	4326	3987	4425	4425
4877 x 1981 (16'0" x 6'6")	-	4574	4865	4865
4877 x 2134 (16'0" x 7'0")	-	4574	4865	4865

### Size availability (mm) for Made to Measure doors

Minimum width	4115	2743	4115	2743
Maximum width	4572	4877	4724	4877
Minimum height	1880	1880	1880	1880
Maximum height	2134	2286	2134	2134

R = Retractable gear.

### GRP double doors - options

Standard frame	£332 (Pre-finished or white painted)
Coloured frame	£361 (Coloured paint)
Glazing (Lyndhurst II)	£189 (Stippled) Black mock glazing standard
Glazing (Sutherland)	£291 (Stippled or plain) Black mock glazing standard
Glazing (Georgian II)	Plain black, Stippled, Transparent, Diamond lattice, Queen Anne lattice, Square lattice (add £281)
Glazing (Chelsea II)	£312

### Woodgrain colour options standard as price list

White  
Magnolia  
Bleached Oak  
Red Mahogany  
Light Oak  
Dark Oak  
Honey Beech  
Teak  
Rosewood  
Dark Mahogany  
Golden Brown  
Ebony  
Irish Oak  
Anthracite Grey

### Woodgrain colour options at additional cost

Blue, Red, Green add £256  
RAL colour of your choice add £320

### High Gloss colour options standard as price list

Gloss White and Gloss Magnolia

**All GRP doors are bespoke and made to order.**

Frames ordered with a double door will be supplied as a separate knocked down item.

## Cardale GRP double doors

### GRP double doors

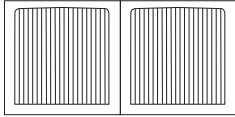
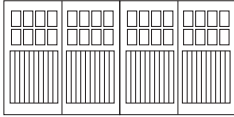
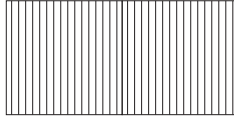
Size mm (ft/in) Width by Height	 <b>Nelson glasswood</b> R	 <b>Sutherland glasswood</b> R	 <b>Virginia glasswood</b> R
	2743 x 1981 (9'0" x 6'6")	-	-
2743 x 2134 (9'0" x 7'0")	-	-	2778
3048 x 1981 (10'0" x 6'6")	-	-	3020
3048 x 2134 (10'0" x 7'0")	-	-	3020
3353 x 1981 (11'0" x 6'6")	-	-	3313
3353 x 2134 (11'0" x 7'0")	-	-	3313
3658 x 1981 (12'0" x 6'6")	-	-	3702
3658 x 2134 (12'0" x 7'0")	-	-	3702
3962 x 1981 (13'0" x 6'6")	-	-	3827
3962 x 2134 (13'0" x 7'0")	-	-	3827
4267 x 1981 (14'0" x 6'6")	3866	3916	3866
4267 x 2134 (14'0" x 7'0")	3866	3916	3866
4572 x 1981 (15'0" x 6'6")	4425	-	4425
4572 x 2134 (15'0" x 7'0")	4425	-	4425
4877 x 1981 (16'0" x 6'6")	4865	-	4865
4877 x 2134 (16'0" x 7'0")	4865	-	4865

### Size availability (mm) for Made to Measure doors

Minimum width	4115	4267	2438
Maximum width	4267	4724	4877
Minimum height	1981	1931	1829
Maximum height	2134	2134	2286

## Cardale GRP side hinged doors

### GRP side hinged doors

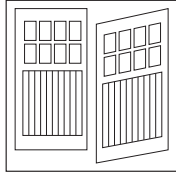
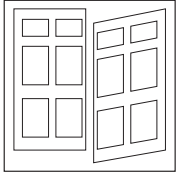
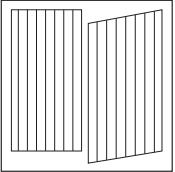
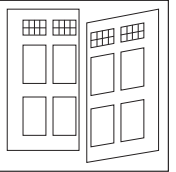
				
	<b>Sutherland glasswood</b> ( $\frac{1}{2}$ - $\frac{1}{2}$ )	<b>Lyndhurst glasswood</b> ( $\frac{1}{2}$ - $\frac{1}{2}$ )	<b>Virginia glasswood</b> ( $\frac{1}{2}$ - $\frac{1}{2}$ )	<b>Georgian II glasswhite</b> ( $\frac{1}{2}$ - $\frac{1}{2}$ )
For available sizes see below	2403	2218	2218	2218

### Size availability (mm)

Minimum width	2134	2134	1830	2134
Maximum width	2438	2438	2438	2438
Minimum height	1930	1930	1830	1930
Maximum height	2134	2134	2134	2134

### Made to Measure doors add £174

#### GRP side hinged doors - options

Unframed	deduct £41
Painted frame	add £30
Glazing (Sutherland)	add £146 (Stippled) Black mock glazing standard
Glazing (Lyndhurst)	add £355 (Stippled, Diamond Lattice, Square Lattice and Plain)
Glazing (Georgian Glasswhite)	add £355 (Stippled, Diamond Lattice, Square Lattice and Plain)
Painted door	add £140
Left hand opening	add £82

Side hinged doors supplied with pre-finished white 50mm frame as standard.  
Doors supplied as standard right hand opening when viewed from outside.

**All side hinged doors come complete with a pair of door stays.**

**All side hinged doors are bespoke and made to order.**

## Cardale GRP personnel door

### GRP single doors

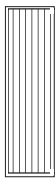
	
	<b>Virginia glasswood</b>
For available sizes see below	1329

#### Personnel door - options

Unframed	deduct £19
Painted frame	£28
Painted door	£131
50mm frame available at no extra cost	
Personnel doors are supplied with pre-finished white frame as standard	

**Made to measure - take next size up and add £70**

**All Personnel doors are bespoke and made to order.**

### Size availability (mm)

Minimum width	720
Maximum width	1220
Minimum height	1930
Maximum height	2134

## Cardale Steeline roller doors

### Curtain width 'A' Series

Opening +50mm (2in) minimum

### Curtain width 'AA' Series

Opening +100mm (4in) minimum

Height mm (ft/in)	2185 7'2"	2337 7'8"	2489 8'2"	2642 8'8"	2794 9'2"	2946 9'8"	3099	3251	3404	3556	3758	4063	4368	4673	4978
<b>2134 (7' 0")</b>	1106	1134	1138	1253	1292	1457	1507	1658	1781	2014	2153	2335	2474	2716	2928
<b>2438 (8' 0")</b>	1238	1267	1246	1358	1414	1507	1614	1766	1884	2204	2356	2612	2865	3027	3189
<b>2743 (9' 0")</b>	1388	1426	1432	1537	1592	1655	1800	2012	2197	2433	2623	2900	3052	-	-
<b>3048 (10' 0")</b>	1567	1662	1633	1726	1765	1826	1983	2247	2503	2769	2993	3166	3501	-	-

#### Ordering notes

Steeline doors are designed to fit behind the brickwork opening, allowing clear drive-through width\*. Please therefore order by the curtain size, ensuring that the curtain width is greater than the opening by: 4'0" – 10'0" wide add 50mm to brickwork. Over 10'0" wide add 100mm to brickwork

Textured Golden Oak or Rosewood - add 20% , Mahogany Woodgrain - add 7%.

Series	Curtain width
--------	---------------

'AA' Series (solid areas) Opening + 100mm (4") minimum

\* The drive-through height is 80mm less than the nominal opening height

### Mini Steeline roller doors

fits in 9" headroom - available in all Cardale

#### Curtain width mm (ft/in)

Height mm (ft/in)	2185 7'2"	2337 7'8"	2489 8'2"	2642 8'8"	2794 9'2"	2946 9'8"	3099 10'2"
<b>2134 (7' 0")</b>	1155	1186	1197	1302	1355	1529	1567

Textured Golden Oak or Rosewood - add 20% , Mahogany Woodgrain - add 7%.

Doors are designed to fit behind the reveal. Doors are supplied with a lock hole unless specified otherwise.

Sizes listed are the ordering sizes. These are the curtain sizes.

**All Steeline roller doors are bespoke and made to order.**

#### Steeline roller door options

Slimline slimdrive operator	£652
Complete lock replacement	£69
Replacement key	£17
Touch up paint	£26
Odd width cut down (applicable to doors under 4' wide)	£108
Non standard brackets	£79
Brush seal for header (3m length)	£225

#### Standard colours

White  
 Anthracite  
 Vandyke Brown  
 Black  
 Goosewing Grey  
 Merlin Grey  
 Olive Green  
 Juniper Green  
 Burgundy  
 Mushroom  
 Honesty Cream  
 Heritage Green  
 Solent Blue  
 Golden Oak  
 Rosewood

## Sectional iso20 Overhead Garage Doors

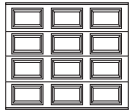

Panelled

### iso20 Panelled Woodgrain

	Standard Widths	2084	2134	2235	2286	2438	2591	2743	3000
Standard Heights	No. of Windows	3	3	3	3	4	4	4	5
1925 2000 2075 2100	White	1078	1078	1078	1078	1078	1291	1291	1308
	Supercolour	1208	1211	1218	1221	1230	1454	1463	1497
	RAL Colour	1333	1339	1351	1359	1377	1610	1628	1677
2250	White	1110	1110	1110	1110	1110	1370	1370	1400
	Supercolour	1249	1252	1257	1261	1272	1543	1553	1600
	RAL Colour	1380	1388	1399	1407	1427	1707	1727	1791
2375 2500	White	1189	1189	1189	1189	1189	1469	1469	1501
	Supercolour	1354	1359	1365	1370	1382	1674	1686	1739
	RAL Colour	1512	1520	1534	1544	1567	1871	1894	1966
2625 2750	White	1531	1531	1531	1531	1531	1922	1922	1951
	Supercolour	1712	1717	1725	1730	1743	2149	2163	2213
	RAL Colour	1886	1894	1910	1920	1947	2365	2390	2463

Not available for heights >2100 and < 2225

Intermediate height or width combination **Add £146.00**

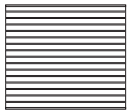

Horizontal

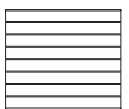

Large Rib

### iso20 Horizontal and Large Rib Woodgrain

	Standard Widths	2084	2134	2235	2286	2438	2591	2743	3000
Standard Heights	No. of Windows	3	3	3	3	4	4	4	5
1925 2000 2075 2100	White	935	935	935	935	935	1040	1040	1068
	Supercolour	1066	1069	1075	1079	1088	1203	1212	1256
	RAL Colour	1191	1197	1210	1216	1235	1359	1377	1437
2250	White	980	980	980	980	980	1152	1152	1270
	Supercolour	1119	1122	1129	1132	1143	1324	1335	1470
	RAL Colour	1251	1257	1271	1277	1298	1489	1509	1660
2375 2500	White	1050	1050	1050	1050	1050	1235	1235	1361
	Supercolour	1215	1220	1227	1231	1243	1440	1453	1599
	RAL Colour	1374	1381	1397	1405	1428	1637	1660	1826
2625 2750	White	1166	1166	1166	1166	1166	1470	1470	1515
	Supercolour	1348	1352	1361	1365	1379	1696	1709	1777
	RAL Colour	1521	1530	1547	1555	1582	1911	1938	2026

Intermediate height or width combination **Add £146.00**

Heights between 2100 and 2225 have cut top panels

## Sectional iso20 Overhead Garage Doors

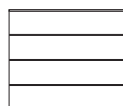

Flush

### iso20 Flush Smooth

	Standard Widths	2084	2134	2235	2286	2438	2591	2743	3000
Standard Heights	No. of Windows	3	3	3	3	4	4	4	5
1925 2000 2075 2125	White	1105	1105	1105	1105	1105	1242	1242	1416
	Supercolour	1236	1239	1245	1249	1258	1405	1414	1605
	RAL Colour	1361	1367	1380	1386	1405	1561	1579	1785
2250	White	1256	1256	1256	1256	1256	1393	1393	1544
	Supercolour	1395	1398	1405	1408	1419	1565	1576	1743
	RAL Colour	1528	1534	1547	1553	1574	1730	1750	1934
2375 2500	White	1346	1346	1346	1346	1346	1492	1492	1655
	Supercolour	1512	1516	1523	1528	1539	1699	1710	1892
	RAL Colour	1669	1677	1692	1701	1724	1894	1918	2120
2625 2750	White	1500	1500	1500	1500	1500	1679	1679	2013
	Supercolour	1681	1686	1694	1699	1712	1906	1919	2275
	RAL Colour	1855	1863	1880	1889	1916	2122	2148	2525

Intermediate height or width combination **Add £146.00**

Heights between 2100 and 2225 have cut top panels

### Optional Extras

**Sectional frame heads are colour matched to the door as standard.**

#### Frame leg cover profiles 2.5m length

White	85mm x 20mm (per pair)	<b>Add £62</b>
	55mm x 20mm (per pair)	<b>Add £62</b>
Super colour	85mm x 20mm (per pair)	<b>Add £77</b>
	55mm x 20mm (per pair)	<b>Add £77</b>
RAL colour	85mm x 20mm (per pair)	<b>Add £117</b>
	55mm x 20mm (per pair)	<b>Add £117</b>
Golden Oak & Rosewood	85mm x 20mm (per pair)	<b>Add £117</b>
	55mm x 20mm (per pair)	<b>Add £117</b>

#### Super colour Options

Steel Blue (RAL 5011), Moss Green (RAL 6005), Fir Green (RAL 6009), Anthracite (RAL 7016), Ochre Brown (RAL 8001), Nut Brown (RAL 8011), Sepia Brown (RAL 8014), Light Grey (RAL 7035), Window Grey (RAL 7040), Black (RAL 9005), White Aluminium (RAL 9006), Grey Aluminium (RAL 9007)

#### Glazing Options (for styles see page 22)

Window option clear/crystal,  
V1, V2, V3 (per window) **White frame add £100**  
**RAL frame add £115**

Window option clear/crystal,  
V4d, V4s (per window) **White frame add £108**  
**RAL frame add £121**

V8 windows not available

**Doors are supplied without locking as standard, ready for automation.**

#### Handle options

Manual locking with Black D Handle **Add £59**  
Metallic 'D' handles  
(White, Brass, Silver and Antique Bronze effect) **Add £121**  
Metallic lever door handles  
(White, Brass, Silver and Antique Bronze effect) **Add £186**

#### Automated Options

See pages 37-38

Sectional doors are bespoke and made to order.

iso20 sectional doors up to 2100mm 4 panels high, up to 2625mm 5 panels high, up to 2750mm 6 panels high  
iso20 sectional doors have an insulation value of k=1.0 W/mK

## Sectional iso45 Overhead Garage Doors

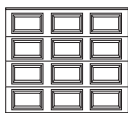

### iso45 Georgian Woodgrain

Available in these Wood Effects finishes: Golden Oak, Dark Oak, Rosewood

	Standard Widths	2084	2134	2235	2286	2388	2438	2591	2743	3048	3353	3658	3962	4216	4267	4420	4572	4877	5182	5500
Standard Heights	Number of Windows	3	3	3	3	3	3	3	4	4	4	4	5	5	5	6	6	6	6	7
1875 1925 2000 2050 2075 2100 2250	White	1243	1243	1243	1243	1243	1243	1509	1509	1875	1875	2081	2081	2203	2203	2203	2366	2366	2563	2563
	Supercolour	1374	1377	1383	1386	1393	1396	1672	1681	2067	2067	2312	2331	2469	2473	2482	2654	2673	2890	2910
	RAL Colour & Wood Effects	1499	1505	1518	1524	1536	1543	1828	1846	2250	2250	2531	2569	2722	2728	2747	2928	2965	3202	3240
2375 2500	White	1507	1507	1507	1507	1507	1507	1825	1825	2242	2242	2675	2675	2834	2834	2834	3051	3051	3335	3335
	Supercolour	1673	1677	1685	1689	1698	1701	2031	2043	2483	2483	2965	2989	3168	3173	3184	3413	3438	3747	3771
	RAL Colour & Wood Effects	1831	1839	1854	1862	1878	1886	2227	2250	2714	2714	3242	3289	3488	3495	3519	3760	3807	4138	4187
2625 2750 2875 3000	White	2605	2605	2605	2605	2605	2605	2733	2733	2768	2768	3051	3051	3258	3258	3258	-	-	-	-
	Supercolour	2803	2808	2818	2822	2832	2837	2980	2994	3057	3058	3399	3428	3660	3664	3679	-	-	-	-
	RAL Colour & Wood Effects	2992	3002	3021	3029	3049	3058	3215	3243	3334	3335	3731	3787	4043	4052	4080	-	-	-	-

iso45 sectional doors up to 2100mm 4 panels high, up to 2500mm 5 panels high, up to 3000mm 6 panels high. Not available for heights >2125 and < 2225.

Intermediate height or width combination Add £146.00

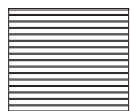

Horizontal Rib  
Woodgrain only

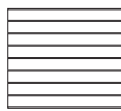

Large Rib

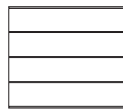

Flush

### iso45 Horizontal, Large Rib and Flush Woodgrain

	Standard Widths	2084	2134	2235	2286	2388	2438	2591	2743	3048	3353	3658	3962	4216	4267	4420	4572	4877	5182	5500
Standard Heights	Number of Windows	3	3	3	3	4	4	4	4	5	5	6	6	7	7	7	7	8	8	8
1875 1925 2000 2050 2075 2100 2250	White	1082	1082	1082	1082	1082	1082	1272	1272	1455	1455	1615	1615	1709	1709	1709	1836	1836	1989	1989
	Supercolour	1267	1270	1277	1281	1287	1290	1500	1509	1721	1740	1928	1949	2063	2067	2077	2220	2241	2420	2440
	RAL Colour	1337	1344	1357	1363	1375	1381	1591	1609	1829	1867	2065	2103	2228	2234	2252	2399	2436	2626	2666
2375 2500	White	1337	1337	1337	1337	1337	1337	1610	1610	2111	2111	2345	2345	2391	2391	2391	2573	2573	2812	2812
	Supercolour	1509	1514	1522	1526	1535	1539	1825	1838	2363	2389	2649	2675	2741	2745	2758	2952	2978	3243	3269
	RAL Colour	1602	1610	1626	1633	1649	1657	1942	1966	2493	2540	2811	2859	2942	2950	2974	3172	3219	3495	3545
2625 2750 2875 3000	White	1981	1981	1981	1981	1981	1981	2074	2074	2332	2332	2571	2571	2746	2746	2746	2961	2961	3090	-
	Supercolour	2188	2192	2203	2207	2218	2223	2331	2346	2636	2666	2935	2965	3165	3171	3186	3416	3447	3607	-
	RAL Colour	2282	2292	2311	2321	2339	2349	2466	2495	2800	2856	3141	3197	3412	3422	3450	3685	3741	3922	-

Intermediate height or width combination Add £146.00

Heights between 2125 and 2225 have cut top panels

# Sectional iso45 Overhead Garage Doors

## iso45 Large Rib Smooth

Available in these Wood Effects finishes: Golden Oak, Dark Oak, Rosewood, Winchester, Night Oak

Available in these Satin finishes: Grey, Dark Grey, White, Window Grey, Brown

	Standard Widths	2084	2134	2235	2286	2388	2438	2591	2743	3048	3353	3658	3962	4216	4267	4420	4572	4877	5182	5500
Standard Heights	Number of Windows	3	3	3	3	4	4	4	4	5	5	6	6	7	7	7	7	8	8	8
1875 1925 2000 2050 2075 2100 2250	White	1188	1190	1195	1198	1203	1206	1404	1411	1610	1610	1801	1817	1924	1926	1935	2070	2084	2253	2269
	Supercolour	1319	1324	1336	1342	1353	1359	1567	1584	1802	1802	2032	2066	2189	2196	2213	2357	2392	2579	2616
	RAL Colour	1444	1453	1470	1479	1497	1505	1722	1749	1985	1986	2251	2305	2443	2451	2478	2632	2685	2890	2946
	Wood Effects	1301	1305	1313	1317	1326	1330	1541	1553	1770	1770	1987	2012	2132	2136	2149	2294	2319	2504	2529
	Satin	1286	1290	1300	1305	1315	1320	1525	1540	1753	1754	1973	2003	2122	2127	2142	2284	2314	2497	2528
2375 2500	White	1477	1481	1487	1490	1498	1501	1784	1794	2315	2336	2591	2611	2675	2678	2687	2880	2901	3161	3182
	Supercolour	1649	1657	1672	1680	1695	1703	1999	2021	2569	2589	2895	2941	3024	3032	3054	3259	3305	3591	3639
	RAL Colour	1736	1748	1769	1781	1803	1814	2109	2142	2688	2709	3047	3114	3212	3224	3257	3464	3532	3828	3897
	Wood Effects	1552	1557	1568	1574	1583	1588	1878	1893	2425	2427	2724	2755	2826	2832	2848	3045	3076	3348	3381
	Satin	1702	1712	1733	1743	1764	1774	2066	2097	2638	2663	2987	3049	3144	3155	3186	3390	3452	3743	3808
2625 2750 2875 3000	White	2149	2152	2160	2165	2172	2176	2282	2295	2578	2578	2866	2890	3085	3089	3102	3330	3354	3508	-
	Supercolour	2356	2365	2383	2392	2411	2419	2540	2568	2882	2882	3229	3285	3505	3515	3541	3785	3840	4024	-
	RAL Colour	2444	2456	2483	2496	2524	2537	2666	2707	3034	3036	3423	3503	3737	3750	3791	4037	4118	4322	-
	Wood Effects	2238	2245	2258	2264	2276	2282	2394	2414	2710	2711	3024	3062	3268	3274	3293	3528	3566	3733	-
	Satin	2204	2212	2227	2234	2249	2257	2369	2391	2684	2684	3003	3048	3253	3260	3283	3512	3556	3726	-

Intermediate height or width combination Add £146.00 Heights between 2125 and 2225 have cut top panels

FOR OPTIONAL EXTRAS SEE PAGE 50

## iso45 Flush Smooth

Flush Smooth available in these Wood Effects finishes: Golden Oak, Dark Oak, Rosewood, Winchester, Night Oak

Flush Smooth available in these Satin finishes: Grey, Dark Grey, White, Window Grey, Brown

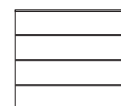

Flush

	Standard Widths	2084	2134	2235	2286	2388	2438	2591	2743	3048	3353	3658	3962	4216	4267	4420	4572	4877	5182	5500
Standard Heights	Number of Windows	3	3	3	3	4	4	4	4	5	5	6	6	7	7	7	7	8	8	8
1875 1925 2000 2050 2075 2100 2250	White	1172	1174	1178	1181	1185	1188	1442	1448	1826	1826	2040	2053	2175	2177	2185	2338	2352	2544	2559
	Supercolour	1302	1308	1319	1324	1336	1342	1605	1622	2017	2018	2269	2304	2440	2446	2463	2625	2660	2870	2905
	RAL Colour	1427	1436	1453	1462	1479	1488	1761	1786	2201	2201	2490	2541	2694	2702	2728	2900	2951	3181	3236
	Wood Effects	1280	1283	1291	1295	1303	1306	1576	1587	1989	1989	2229	2251	2385	2389	2401	2564	2588	2796	2821
	Satin	1264	1268	1277	1282	1291	1296	1555	1569	1960	1960	2201	2228	2360	2366	2380	2539	2567	2773	2802
2375 2500	White	1530	1533	1538	1541	1548	1551	1829	1839	2290	2291	2656	2676	2836	2839	2849	3055	3074	3134	3153
	Supercolour	1702	1709	1724	1732	1747	1753	2044	2066	2543	2544	2960	3004	3186	3193	3215	3435	3478	3564	3610
	RAL Colour	1786	1797	1819	1830	1851	1862	2152	2185	2664	2665	3110	3175	3367	3378	3411	3632	3698	3802	3871
	Wood Effects	1599	1605	1614	1618	1628	1633	1916	1931	2392	2393	2779	2808	2977	2982	2997	3208	3238	3308	3338
	Satin	1745	1754	1774	1784	1803	1814	2099	2129	2603	2628	3036	3095	3283	3292	3322	3540	3599	3699	3761
2625 2750 2875 3000	White	2298	2303	2310	2313	2321	2325	2522	2533	2740	2740	3042	3065	3273	3277	3288	3531	3554	-	-
	Supercolour	2506	2514	2532	2541	2559	2568	2780	2806	3043	3044	3407	3459	3693	3702	3729	3986	4040	-	-
	RAL Colour	2587	2600	2626	2639	2666	2679	2896	2934	3189	3190	3592	3671	3917	3929	3969	4230	4309	-	-
	Wood Effects	2383	2388	2400	2405	2417	2423	2626	2644	2863	2863	3190	3225	3443	3448	3467	3716	3751	-	-
	Satin	2338	2345	2359	2367	2381	2387	2586	2607	2825	2825	3156	3197	3413	3421	3442	3684	3726	-	-

Intermediate height or width combination Add £146.00

Heights between 2125 and 2225 have cut top panels

## Sectional iso45 Overhead Garage Doors (continued)



Microline

### iso45 Microline

Microline available in these Satin finishes: Grey, Dark Grey, White, Window Grey

	Standard Widths	2084	2134	2235	2286	2388	2438	2591	2743	3048	3353	3658	3962		4267	4420	4572	4877	5182	5500
Standard Heights	Number of Windows	3	3	3	3	4	4	4	4	5	5	6	6	7	7	7	7	8	8	8
1875 1925 2000 2050 2075 2100 2250	Satin	1224	1228	1236	1239	1246	1250	1507	1519	1903	1904	2133	2155	2282	2285	2297	2454	2477	2677	2699
2375 2500	Satin	1854	1865	1891	1904	1928	1941	2235	2273	2762	2809	3226	3302	3503	3515	3553	3779	3855	3969	4047
2625 2750 2875 3000	Satin	2280	2285	2296	2301	2313	2319	2513	2530	2739	2740	3052	3086	3295	3300	3317	3555	3588	-	-

Intermediate height or width combination Add £146.00

Heights between 2125 and 2225 have cut top panels

iso45 sectional doors up to 2125mm 4 panels high, up to 2500mm 5 panels high, up to 3000mm 6 panels high.

iso45 sectional doors have an insulation value of k= 0.5 W/mK

For heights > 2125 < 2225 the top panel will be cut to suit the door height. Minimum sizes 2000mm width and 1875 height

### Optional Extras for iso45 doors

**Sectional frame heads are colour matched to the door as standard.**

**Frame leg cover profiles 2.5 m length**

White	85mm x 20mm (per pair)	Add £62
	55mm x 20mm (per pair)	Add £62
Super colour	85mm x 20mm (per pair)	Add £77
	55mm x 20mm (per pair)	Add £77
RAL colour	85mm x 20mm (per pair)	Add £117
	55mm x 20mm (per pair)	Add £117
Wood Effects	85mm x 20mm (per pair)	Add £117
& Satins	55mm x 20mm (per pair)	Add £117

**Super colour Options**

Steel Blue (RAL 5011), Moss Green (RAL 6005), Fir Green (RAL 6009), Anthracite (RAL 7016), Ochre Brown (RAL 8001), Nut Brown (RAL 8011), Sepia Brown (RAL 8014), Light Grey (RAL 7035), Window Grey (RAL 7040), Black (RAL 9005), White Aluminium (RAL 9006), Grey Aluminium (RAL 9007)

**Rustic wood effects (smooth finish), iso45 only**

Golden Oak, Dark Oak, Rosewood, Night Oak, Winchester

**Structural surfaces, iso45 only**

Satin White (RAL 9016), Satin Dark Grey (RAL 7016), Satin Brown (RAL 8014), Satin Grey (composite shade), Window Grey (RAL 7040)

Not available in Iso45 Panelled

**Microline pattern iso45 only**

Satin White (RAL 9016), Satin Grey (composite shade), Satin Dark Grey (RAL 7016), Satin Window Grey (RAL 7040)

**Equivalent RAL colours for painted window frames:**

Golden Oak (RAL 8007) Rosewood (composite colour), Dark Oak (RAL 8028), Satin White (RAL 9016) Satin Grey (composite colour), Satin Dark Grey, (RAL 7016), Satin Window Grey (RAL 7040), Satin Brown (RAL 8014), Night Oak\* (RAL 8022), Winchester\* (RAL 8001)

\*All colour profiles have matching finishes except for Night Oak and Winchester which are painted. Colour variations may occur due to production processes and does not constitute a complaint.

**Glazing Options** (for styles see page 22)

Window option clear/crystal,

V1, V2, V3 (per window)

White frame add £101

RAL frame add £115

Window option clear/crystal,

V4d, V4s (per window)

White frame add £101

RAL frame add £115

Window option V7

aluminium light strip

£373

Window option clear/crystal

V8 Portholes - Large rib and flush doors only. (per window)

Each Add £373

Window option

Aluminium finish V8 Square (per window)

Add £355

**Handle options**

Manual locking with Black D Handle

Add £59

Metallic 'D' handles

(White, Brass, Silver and Antique Bronze effect)

Add £121

Metallic lever door handles

(White, Brass, Silver and Antique Bronze effect)

Add £186

Low Headroom Kit Iso45mm

£129

Ventilation grill to suit iso45

Add £40

**Automated Options**

See pages 37-38

**Wicket doors only available in iso45**

See page 8

Sectional doors are bespoke and made to order.

awaiting information for ABS doors

## Cardale Thermaglide roller doors

### Thermaglide 77mm insulated roller doors

#### Coloured

Guide height mm (ft/in)	Over guide width up to mm (ft/in)					
	2500 (8'2 <sup>3</sup> / <sub>8</sub> "")	3000 (9'10 <sup>1</sup> / <sub>8</sub> "")	3500 (11'5 <sup>1</sup> / <sub>4</sub> "")	4000 (13'1 <sup>1</sup> / <sub>2</sub> "")	4600 (15'1 <sup>1</sup> / <sub>8</sub> "")	5000 (16'4"")
1981 (6'6"")	1589	1744	1873	2121	2272	2606
2134 (7'0"")	1607	1760	1881	2137	2373	2679
2286 (7'6"")	1662	1810	1921	2312	2498	2786
2438 (8'0"")	1686	1908	1945	2295	2577	2774
2591 (8'6"")	1876	1983	2081	2504	2674	3070
2743 (9'0"")	1905	2031	2106	2583	3010	3218

#### Woodgrain

Guide height mm (ft/in)	Over guide width up to mm (ft/in)					
	2500 (8'2 <sup>3</sup> / <sub>8</sub> "")	3000 (9'10 <sup>1</sup> / <sub>8</sub> "")	3500 (11'5 <sup>1</sup> / <sub>4</sub> "")	4000 (13'1 <sup>1</sup> / <sub>2</sub> "")	4600 (15'1 <sup>1</sup> / <sub>8</sub> "")	5000 (16'4"")
1981 (6'6"")	1959	2166	2357	2685	2976	3295
2134 (7'0"")	1951	2160	2343	2723	3010	3381
2286 (7'6"")	2040	2248	2417	2752	3116	3479
2438 (8'0"")	2086	2378	2543	2860	3319	3603
2591 (8'6"")	2378	2576	2836	3170	3587	3837
2743 (9'0"")	2576	2621	2775	3332	3529	4481

Door width mm (ft/)	2500 (8'2 <sup>3</sup> / <sub>8</sub> "")	3000	3500	4000	4600	5000 (16'4"")
Half box	156	170	184	205	220	242
Full box	234	264	298	327	369	406

Thermaglide 77 doors are supplied with colour matched guide rails as standard. Up to 3 metre - 70mm guide rails. Over 3 metre - 90mm guide rails.

**Half and Full boxes are supplied as white unless any of the other door colours are specified.** All Thermaglide77 doors are supplied as standard with 270mm steel headplates that are not suitable for half or full box. Half or full boxes are supplied with 300mm steel headplates.

### Thermaglide 55mm insulated roller doors

#### Coloured

Guide height mm (ft/in)	Over guide width up to mm (ft/in)		
	1981 (6'6"")	2500 (8'2 <sup>3</sup> / <sub>8</sub> "")	2896 (9'5"")
1981 (6'6"")	1608	1690	1771
2134 (7'0"")	1634	1663	1850
2286 (7'6"")	1712	1816	1970
2438 (8'0"")	1927	1979	2119

#### Woodgrain

Guide height mm (ft/in)	Over guide width up to mm (ft/in)		
	1981 (6'6"")	2500 (8'2 <sup>3</sup> / <sub>8</sub> "")	2896 (9'5"")
1981 (6'6"")	1608	1690	1771
2134 (7'0"")	1634	1663	1850
2286 (7'6"")	1712	1816	1970
2438 (8'0"")	1927	1979	2119

Thermaglide 55 doors are supplied with 65mm colour matched guide rails and full box as standard.

**Full boxes are supplied white as standard.**

#### Thermaglide roller door - options

Emergency manual override	£179	Wireless key pad	£220
Handset 1 button	£64	Alarm*	£120
Handset 4 button	£85	Wired key switch	£64
Wired push button	£16	Vision lath 77	£40/m
Colour matched box	£52/m	Vented lath 77	£36/m
Wireless push button	£96		

#### Thermaglide 77 low maintenance powdercoat finishes

White RAL 9016, Mocca RAL 8019, Black RAL 9005, Burgundy RAL 3004, Racing Green RAL 6009, Blue RAL 5011, Beige RAL 1019, Chartwell Green RAL 6021, Ageta Grey RAL 7038, Anthracite Grey RAL 7016, Rosewood, Golden Oak

#### Thermaglide 77 high grade woodgrain laminate finishes

Black, Anthracite Grey, Golden Oak, Rosewood, Moss Green, Mahogany, Steel Blue

#### Thermaglide 55 low maintenance powdercoat finishes

White RAL 9016, Mocca RAL 8019, Black RAL 9005, Burgundy RAL 3004, Racing Green RAL 6009, Blue RAL 5011, Ageta Grey RAL 3038, Anthracite Grey RAL 7016, Golden Oak

#### Thermaglide 55 weathergrain wood laminate finishes

Rosewood, Golden Oak

**All Thermaglide roller doors are bespoke and made to order.**

# Technical information

## Side Sectional Garage Doors

### Lateral cross section

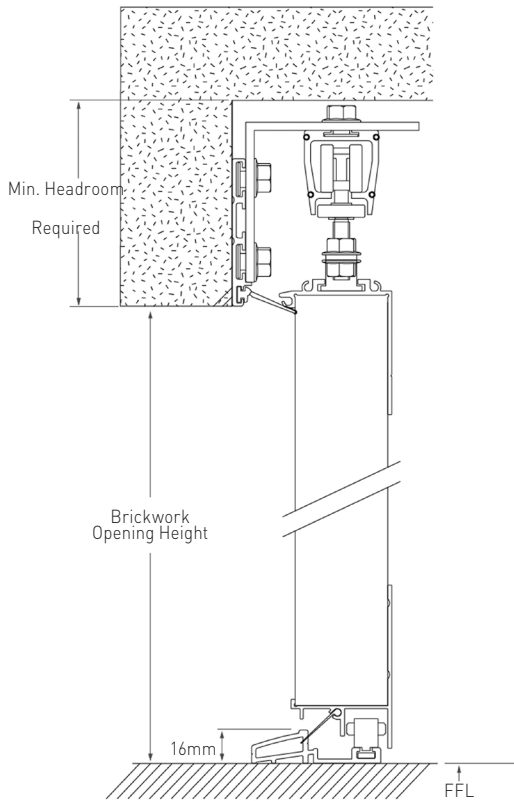

### Installation dimensions

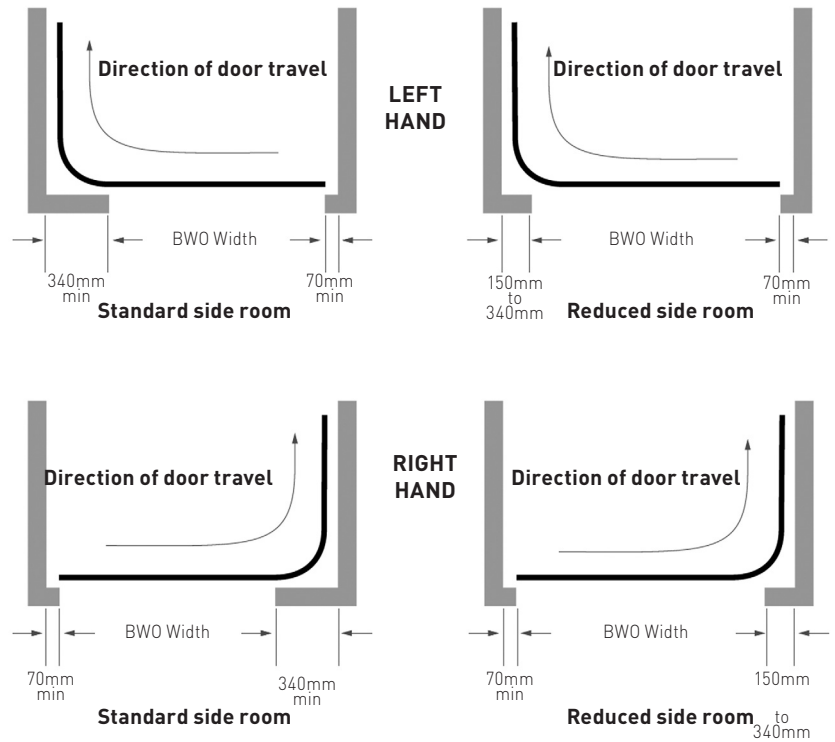

### Specification

The door panels are made of self supporting steel construction, double-skinned with CFC free foam between two steel cover skins, fully galvanised with base paint.

Woodgrain texture on outer face of all panels, all styles (narrow rib, flush and panelled).

Panel thickness of 45mm, with heat insulation value of  $K = 0.5 \text{ W/m}^2\text{K}$ .

Galvanised header track with fastening anchor.

Header, floor and side seals are preassembled (continuous brush seal on 4 sides).

Side rebate - lock side must be at least 70mm.

Side rebate - curve side must be at least 340mm.

Headroom must be at least 100mm.

## Technical information

### iso45 & 20 Overhead Sectional Garage Doors E® Spring up to 3000mm wide x 2700mm high

iso45 sizes above 3000mm x 2700mm are supplied with front mount torsion spring as standard.  
All sectional doors including wicket doors are supplied with front mount torsion spring as standard.

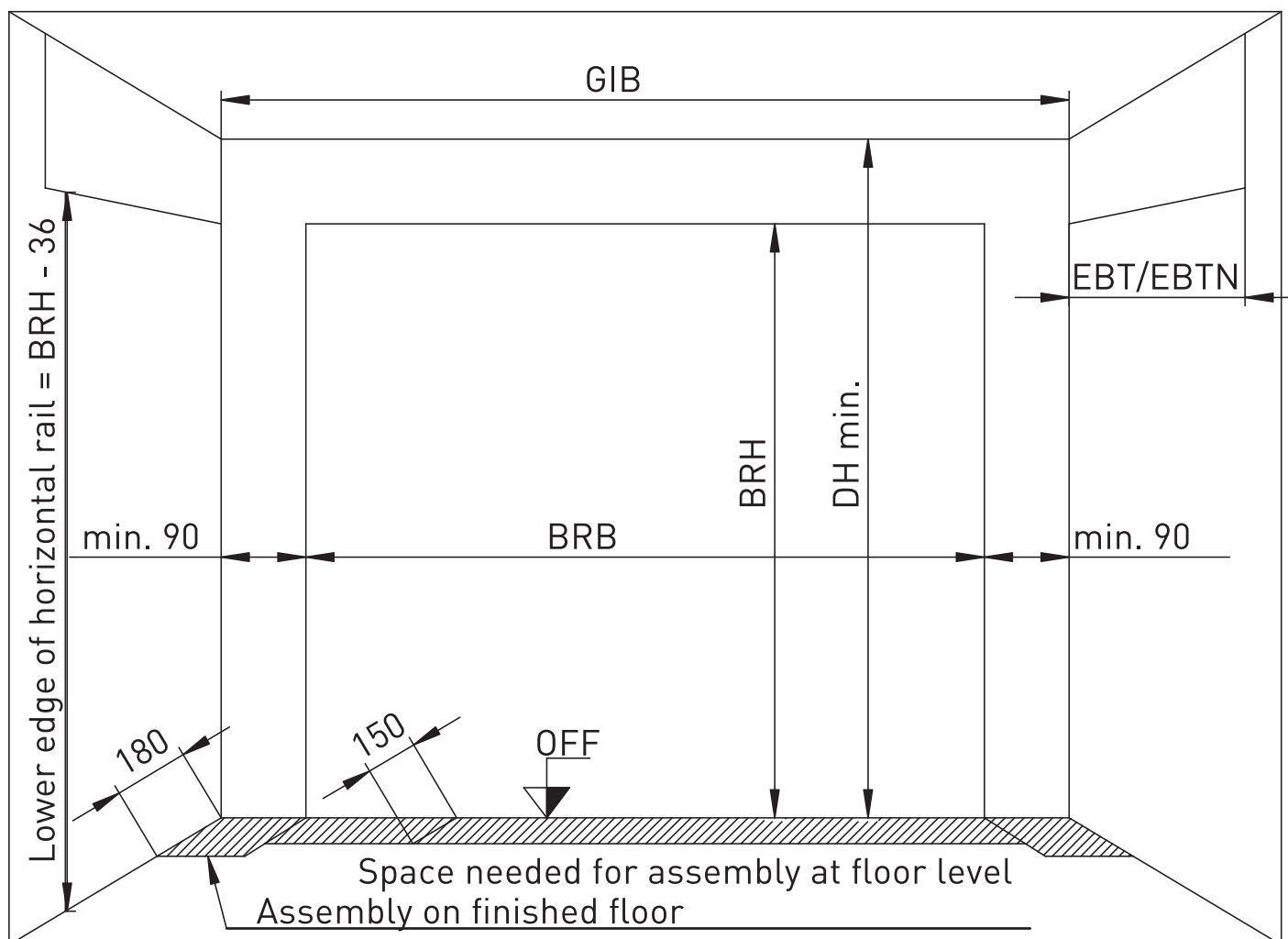

### Required installation dimensions

- BRB = Coordinating width (order size)
- BRH = Coordinating height (order size)
- DH = Ceiling height (minimum dimension)
- GIB = Interior garage width (minimum dimension)
- EBT = Installation depth of the door
- EBTN = Installation depth of garage door with Novomatic operators
- RAMB = Outer frame width
- RAMH = Outer frame height
- OFF = Upper-edge finished floor
- LDH = Clear passage height

Please consult the "Coordinating widths and heights" chart or calculate the dimensions based on the drawings.  
If the structure does not have the required minimum dimensions, it can be compensated by fitting panels and profiles.  
All dimensions in mm.

# Technical information

## iso45 & 20 Overhead Sectional Garage Doors E® Spring up to 3000mm wide x 2700mm high

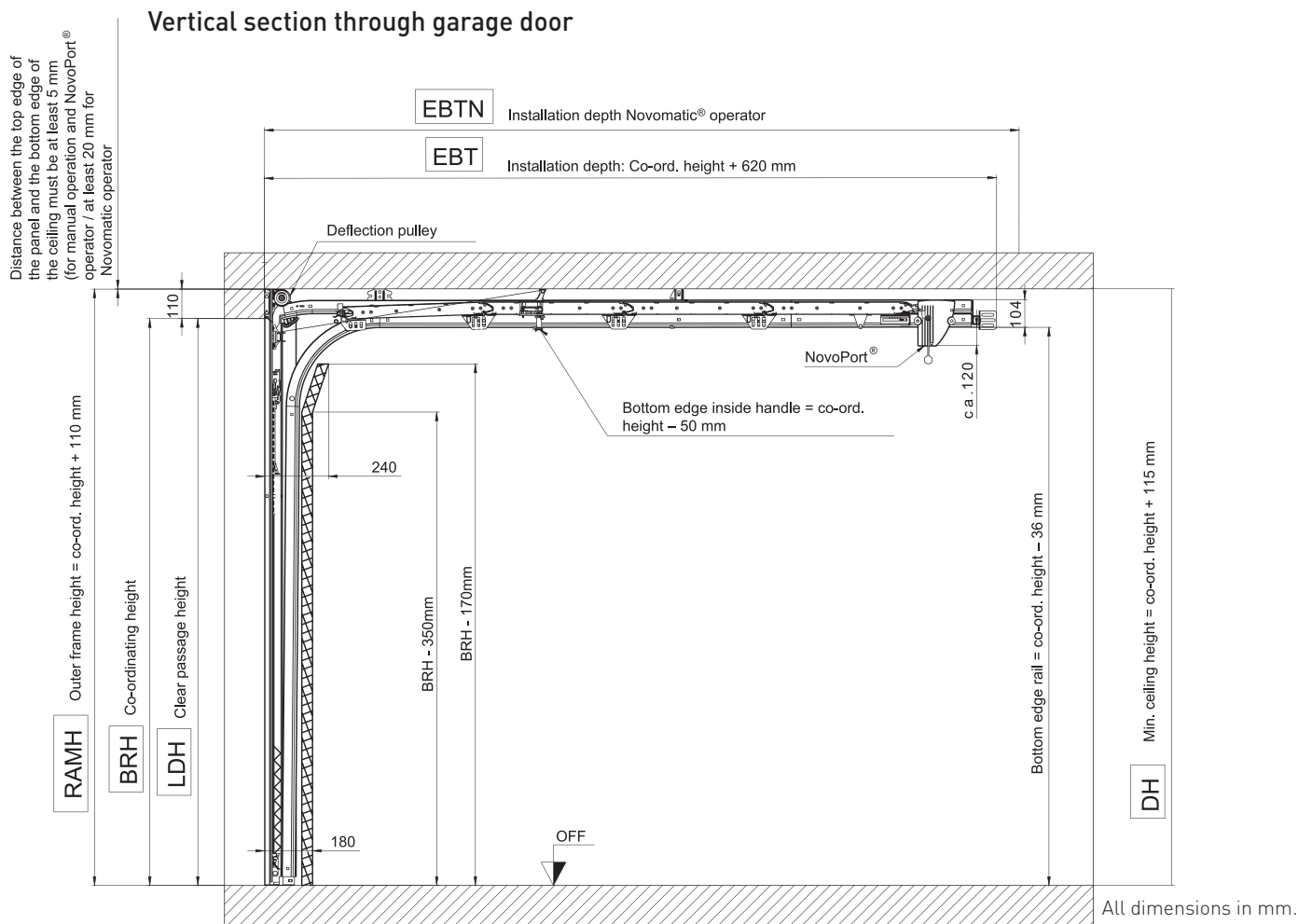

### Horizontal section through garage door

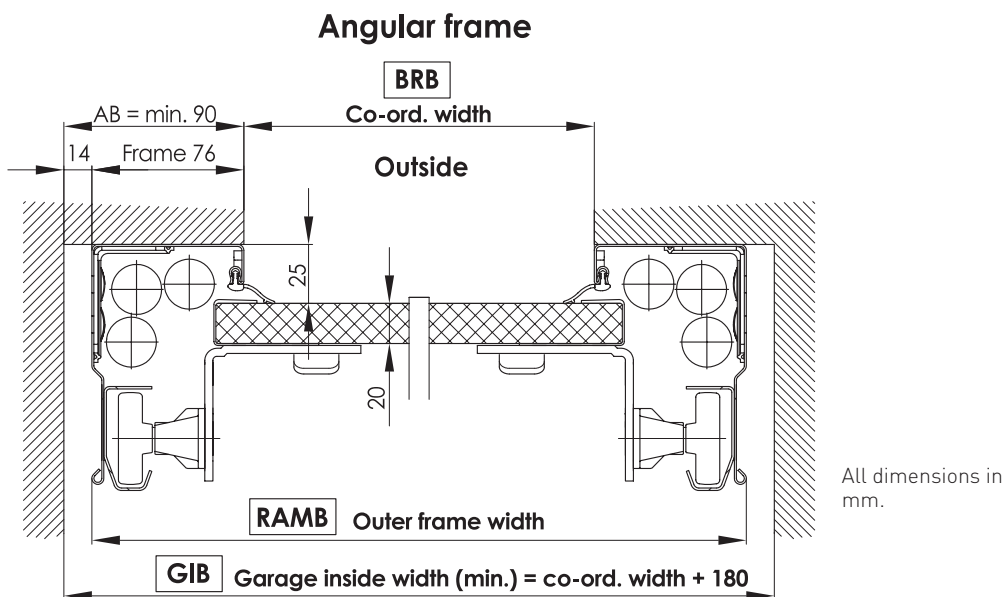

### Ordering information

To calculate the correct door order size to fit within a structural opening, deduct 180mm from the width and 120mm (rear mount) or 215mm (front mount) from the height. For behind the reveal fit calculate from drawings (using required headroom for front/rear mount).

# Technical information

## iso45 Overhead Sectional Garage Doors Torsion Springs

All doors with Wicket doors have torsion springs

### Rear mounted torsion spring detail

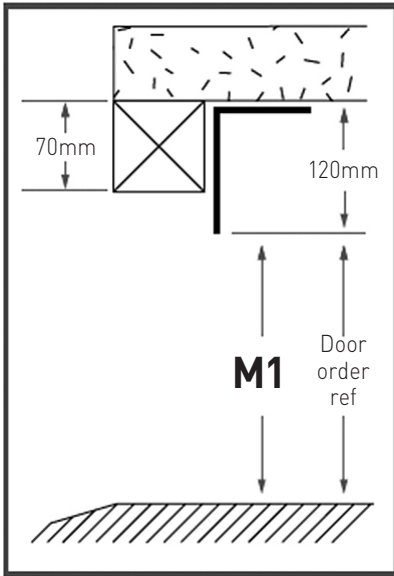

### Fitting within the opening

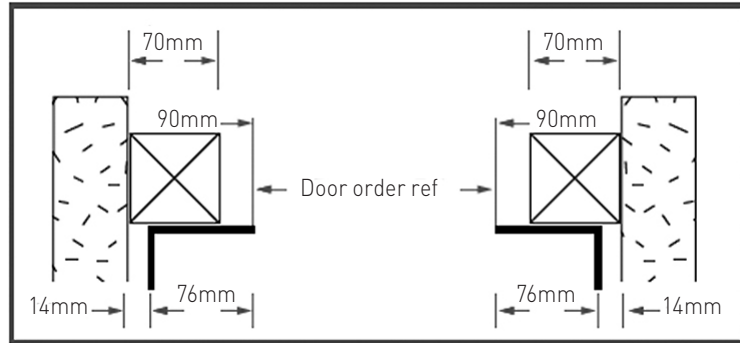

Order ref height	Standard size heights			
	M1	M2	M3	M4
6'4"	1925	2045	2050	2690
6'6"	2000	2120	2125	2765
6'10"	2075	2195	2200	2840
7'0"	2125	2245	2250	2890

CPH Clear Passage Height (with NovoPort®)  
 COH (M1) Co-ord Height  
 OFH (M2) Outer Frame Height  
 CH (M3) min. Ceiling Height  
 ID (M4) min. Installation Depth

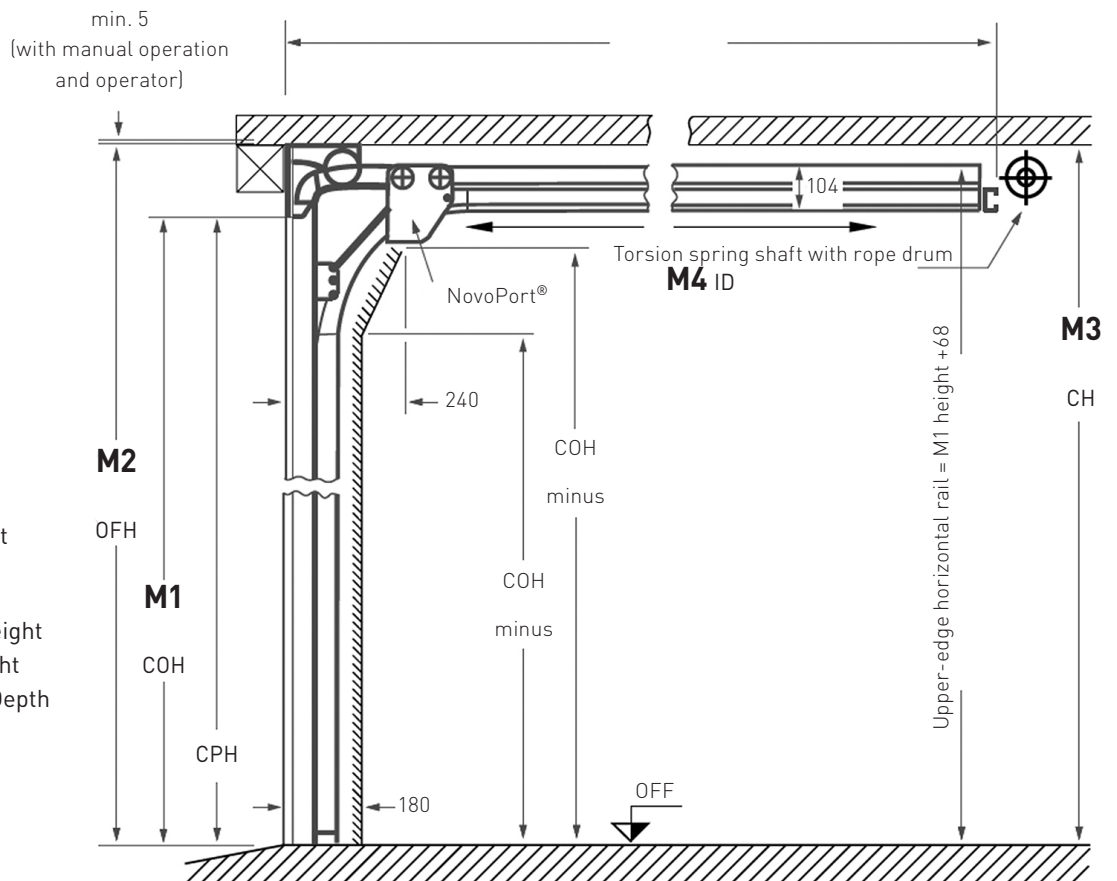

# Technical information

## iso45 Overhead Sectional Garage Doors Torsion Springs

### Front mounted torsion spring detail

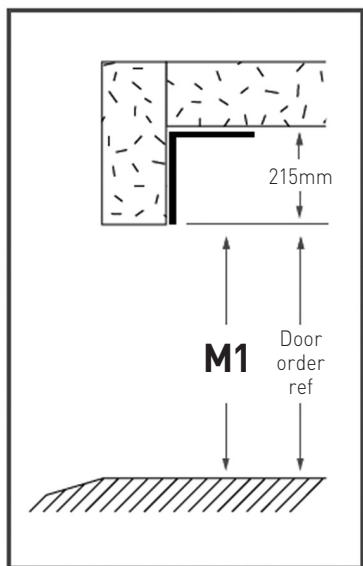

### Fitting behind the opening

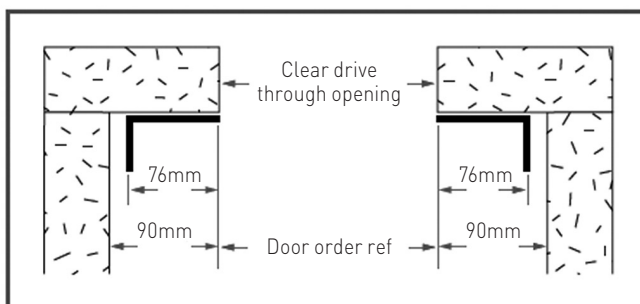

Order ref height	Standard size heights			
	M1	M2	M3	M4
6'4"	1925	2140	2145	2505
6'6"	2000	2215	2220	2580
6'10"	2075	2290	2295	2655
7'0"	2125	2340	2345	2705

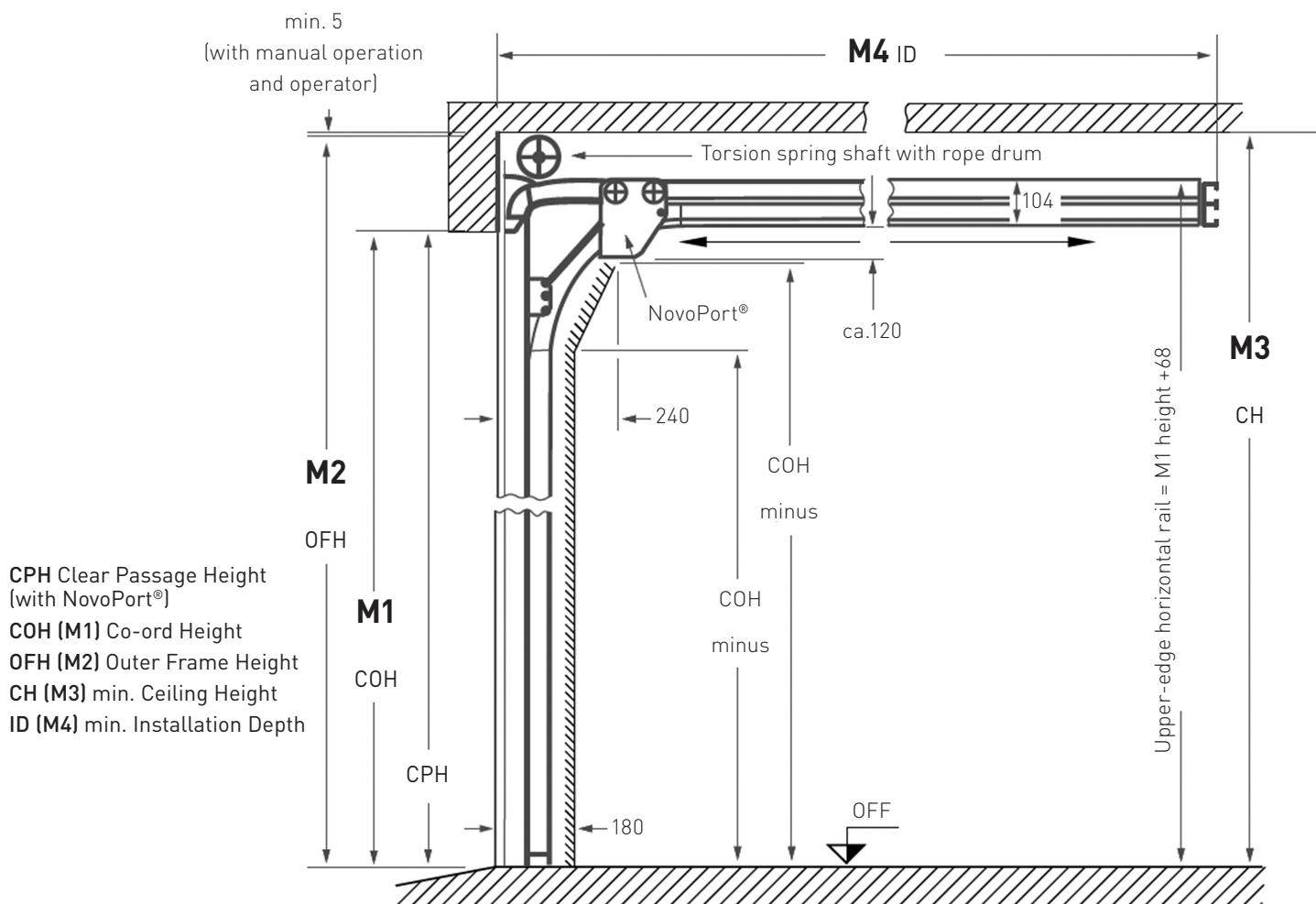

CPH Clear Passage Height (with NovoPort®)  
 COH (M1) Co-ord Height  
 OFH (M2) Outer Frame Height  
 CH (M3) min. Ceiling Height  
 ID (M4) min. Installation Depth

# Technical information

## Matching Side Doors

### Side door handing options

(Please specify when ordering)

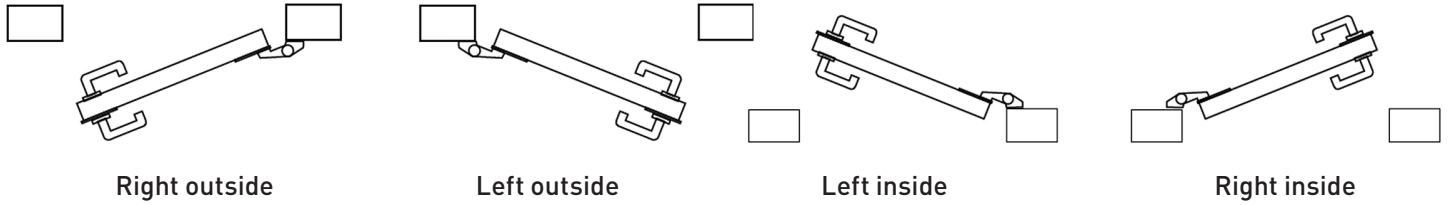

## Up & over one piece matching side doors

(To match steel and timber infill doors)

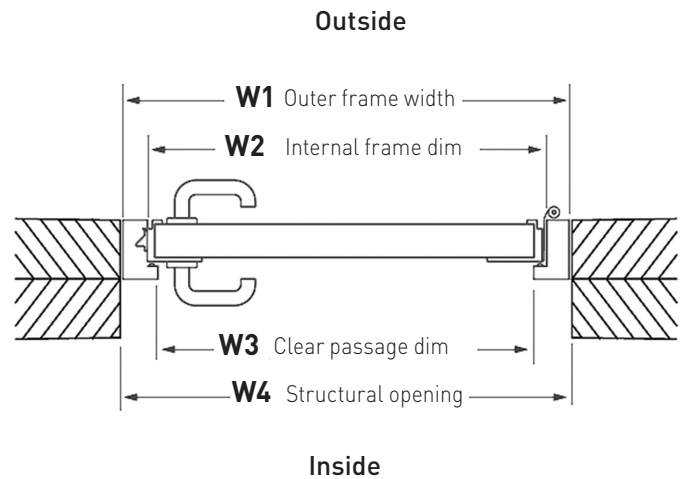
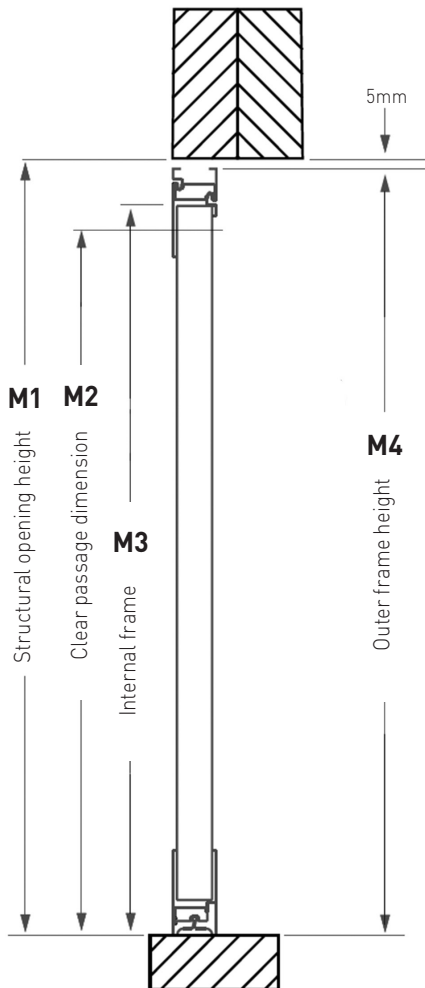

Order ref width	W1	W2	W3	W4
875	932	862	832	945
1000	1057	987	957	1070

Frame leg dimensions 68mm wide x 55mm deep

Order ref height	M1	M2	M3	M4
2000	2055	1978	2000	2050
2125	2180	2103	2125	2175

# Technical information

## Matching Side Doors

### iso45 sectional matching side doors

(To match iso20 and iso45 steel sectional overhead doors)

#### Door opening inwards

vertical section

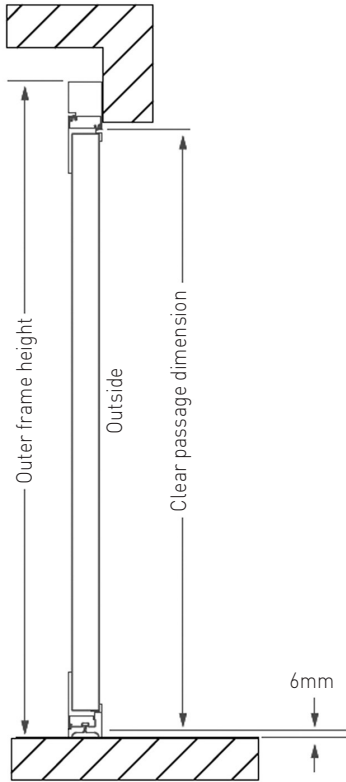

#### Door opening inwards - standard size

horizontal section

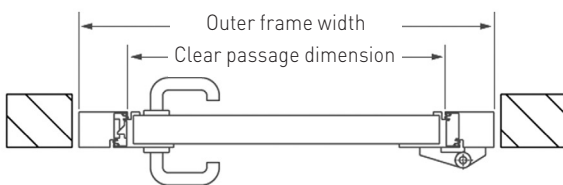

#### Standard sizes

horizontal rib, large rib, flush, raised panel

Door order ref	Order sizes	Clear passage
875 x 2000	995 x 2060	845 x 1970
875 x 2125	995 x 2185	845 x 2095
1000 x 2000	1120 x 2060	970 x 1970
1000 x 2125	1120 x 2185	970 x 2095

Frame leg dimensions 68mm wide x 55mm

#### Door opening inwards and outwards

vertical section

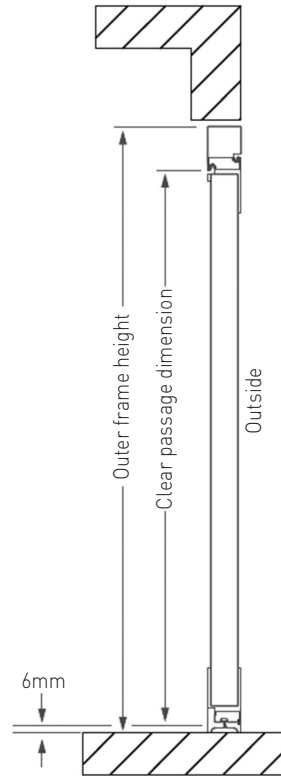

#### Door opening inwards and outwards - special size

horizontal section

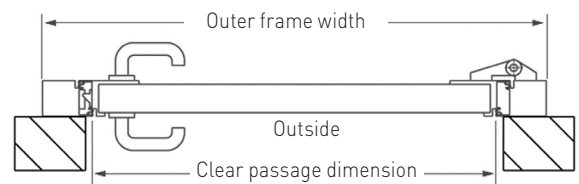

# Technical information

## Single Up & Over Garage Doors. Canopy Gear Type

### Standard Door Heights

Door height		=H1+50	=H1	=H1-150					
imp	mm	H1	H2	H3	H4	H5	H6	R	C
6'4"	1931	1931	1981	1931	1781	1300	49	675	625
6'6"	1981	1981	2031	1981	1831	1300	49	725	657
6'10"	2085	2085	2135	2085	1935	1300	49	825	775
7'0"	2134	2134	2184	2134	1984	1300	49	880	825

H1 = Internal Frame Height

H2 = Minimum Height from floor to underside of ceiling

H3 = Minimum Brickwork Opening Height

H4 = Clear Drive Through Height (Internal Handle is the lowest point)

H5 = How far the door extends into the garage from the back of the brickwork opening

H6 = Kick Up (The height above the Internal Frame Height the door panel rises during the opening cycle)

R = The Arc of travel of the bottom edge of the door

C = The canopy (How far the door protrudes from the frame front)

Note:- The Kick up is greater than the frame Lintel Height and peeks above the Lintel at 1100mm into the garage from the frame front

Frame Header Dimensions 45mm high 40mm deep

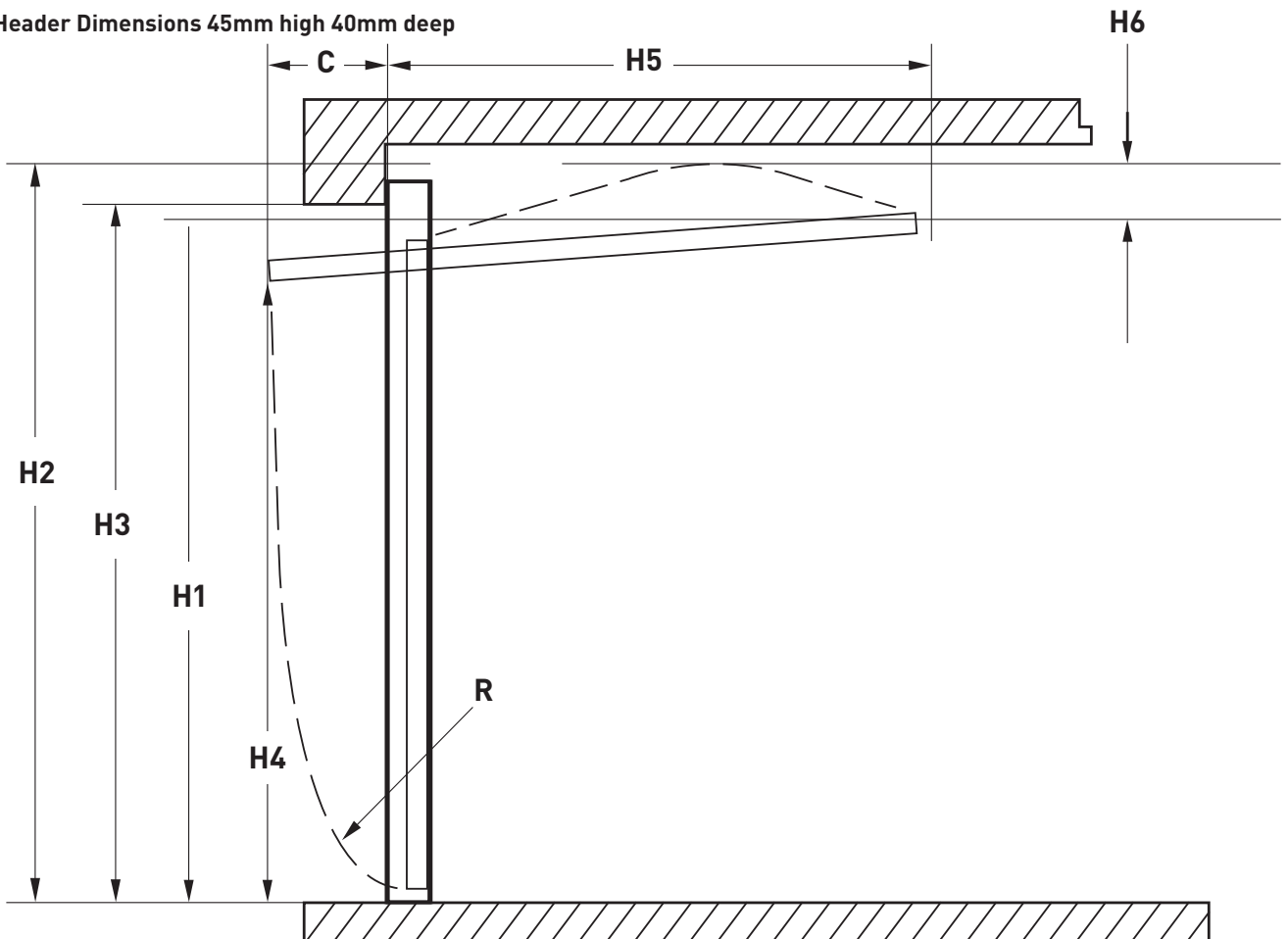

# Technical information

## Single Up & Over Garage Doors. Canopy Gear Type

### Standard Door Widths

Door width		Common dimensions			54mm wide frame x 40mm wide	
		=W1	=W1	=W1+24		
imp	mm	W1	W2	W3	W4	W5
6'10"	2085	2085	2085	2109	2193	2199
7'0"	2134	2134	2134	2158	2242	2248
7'3"	2210	2210	2210	2234	2318	2324
7'5"	2261	2261	2261	2285	2369	2375
7'6"	2286	2286	2286	2310	2394	2400
8'0"	2438	2438	2438	2462	2546	2552

W1 = Internal Frame Width  
W2 = Clear Drive Through Width  
W3 = Minimum Brickwork Opening (fitting behind)  
W4 = Recommended Brickwork Opening Width  
W5 = Recommended Brickwork Opening Width

### Fitting behind the opening

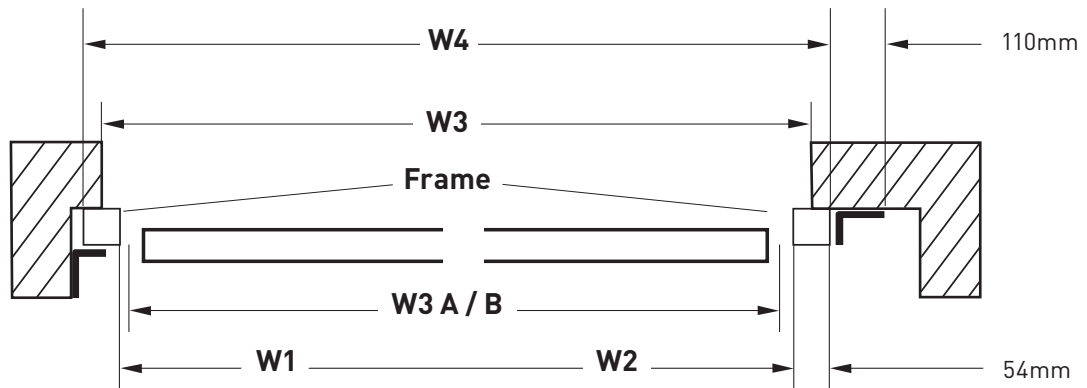

### Fitting within the opening

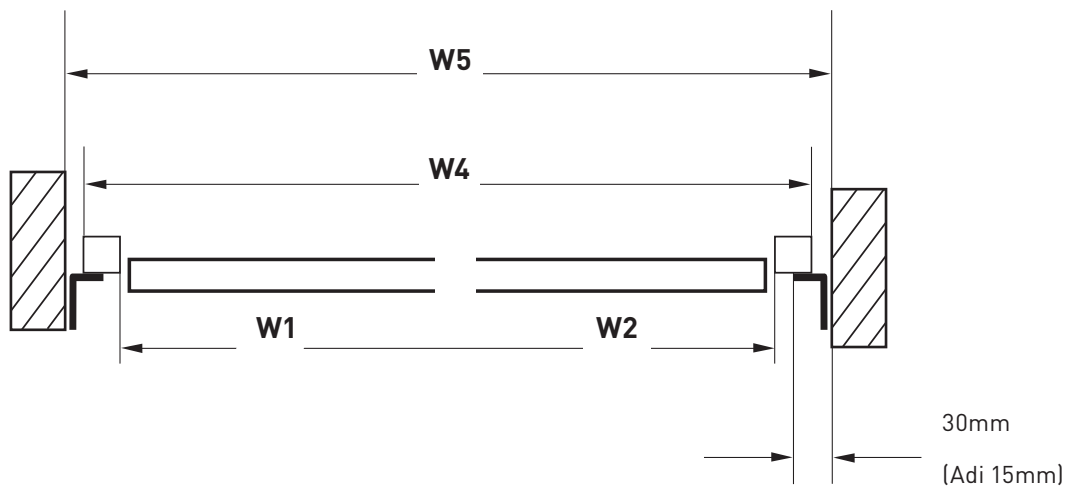

# Technical information

## Up & Over Garage Doors. Single Retractable Gear Type

### Standard Door Heights

For Doors with Frame header 45mm High and 40mm Deep (Steel and Timber Doors)									
Door height			=H1+45	=H1	= H1-150				Lever Arm Crank
Imp	mm	H1	H2	H3	H4	H5	R	C	
6'6"	1981	1981	2026	1981	1831	1735	1020	225	1030
7'0"	2134	2134	2180	2134	1984	1890	1100	265	1100

For doors with Frame Header 68mm High and 60mm Deep (GRP DOORS)									
Door height			=H1+68	=H1	= H1-100				Pivot Arm Crank Height
Imp	mm	H1	H2	H3	H4	H5	R	C	
6'6"	1981	1981	2049	1981	1881	1880	800	40	1050
7'0"	2134	2134	2202	2134	2034	1880	1030	230	1200

H1 = Internal Frame Height

H2 = External Frame Height

H3 = Minimum Brickwork Opening Height

H4 = Clear Drive Through Height (Internal Handle is the lowest point) For manual doors only

H5 = How far the door extends into the garage

R = The arc of travel of the bottom edge of the door

C = The canopy (How far the door protrudes from the frame front)

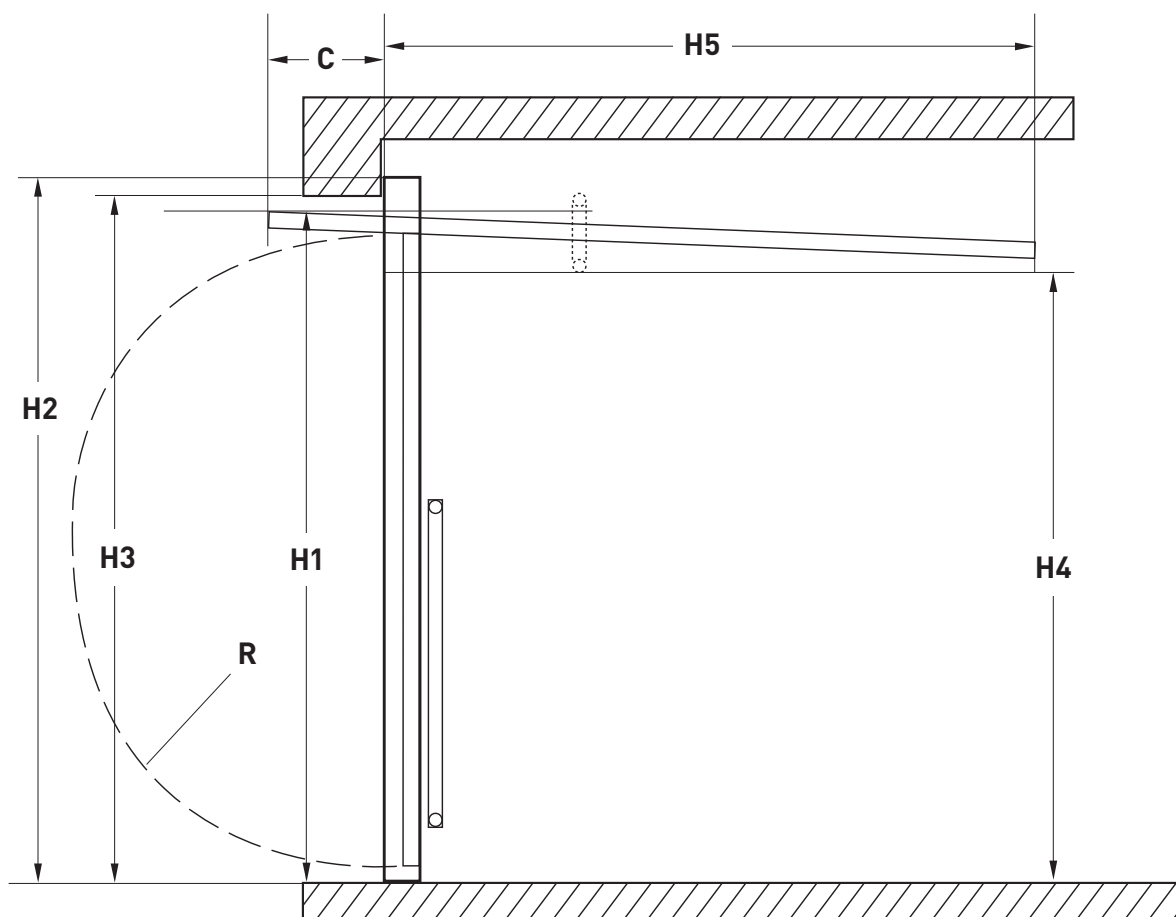

# Technical information

## Up & Over Garage Doors. Single Retractable Gear Type

### Standard Door Widths

Door Width		Common Dimensions				70mm wide frame		FOR GRP DOORS 68mm Wide Frame	
		70mm Wide	=W1+24	=W1-100	=W1-36	=W1+140	=W1+160	= W1 + 136	=W1 + 146
Imp	mm	W1	W2	W3A	W3B	W4	W5	W4	W5
6'10"	2085	2085	2109	1985	2049	2225	2245	2221	2231
7'0"	2134	2134	2158	2034	2098	2274	2294	2270	2280
7'3"	2210	2210	2234	2110	2174	2350	2370	2346	2356
7'5"	2261	2261	2285	2161	2225	2381	2421	2397	2407
7'6"	2286	2286	2310	2186	2250	2426	2446	2422	2432
8'0"	2438	2438	2462	2338	2402	2580	2598	2574	2584
9'0"	2743	2743	2767	2643	2707	2883	2903	N / A	N / A
10'0"	3048	3048	3072	2948	3011	3188	3208	N / A	N / A

W1 = Internal Frame Width

W2 = Minimum Brickwork Opening

W3A = Clear Drive through Width – Above the Crank of the Pivot Arm

W3B = Clear Drive through Width – Below the Crank of the Pivot Arm

W4 = External Frame Width

W5 = Recommended Brickwork Opening Width

NOTE When the Side Wall is between 400 and 750mm away from the opening aperture then an additional bracing kit is required to support the Rear Spacer Bar

### Fitting behind the opening

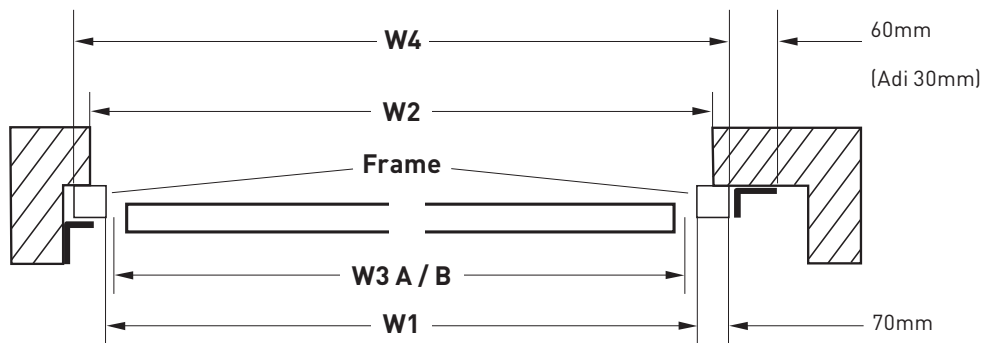

### Fitting within the opening

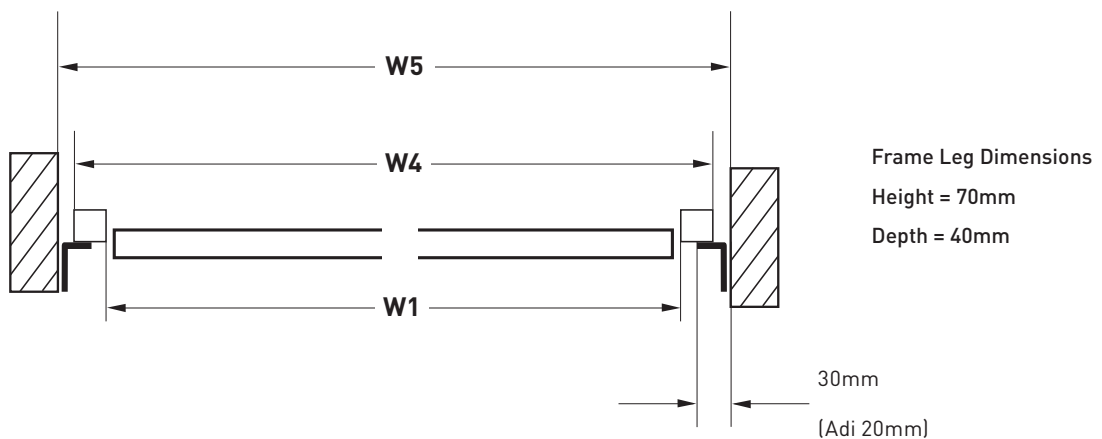

# Technical information

## Double Up & Over Garage Doors. Retractable Gear Type

### Standard Door Heights

Door height			=H1+68	=H1	= H1-			
Imp	mm	H1	H2	H3	H4	H5	R	C
6'6"	1981	1981	2048	1981	1831	1870	900	60
7'0"	2134	2134	2202	2134	1984	1870	1040	210
7'6"	2286	2286	2354	2286	2136	1870	1180	360
8'0"	2438	2438	2506	2438	2288	1870	1320	510

H1 = Internal Frame Height

H2 = External Frame Height

H3 = Minimum Brickwork Opening Height

H4 = Clear Drive Through Height (Internal Handle is the lowest point)

H5 = How far the door extends into the garage

R = The arc of travel of the bottom edge of the door

C = The canopy (How far the door protrudes from the frame front, Assumes 70mm thick frame)

K = Kick up = 43mm

Frame Header Dimensions

Height = 68mm

Depth = 75mm

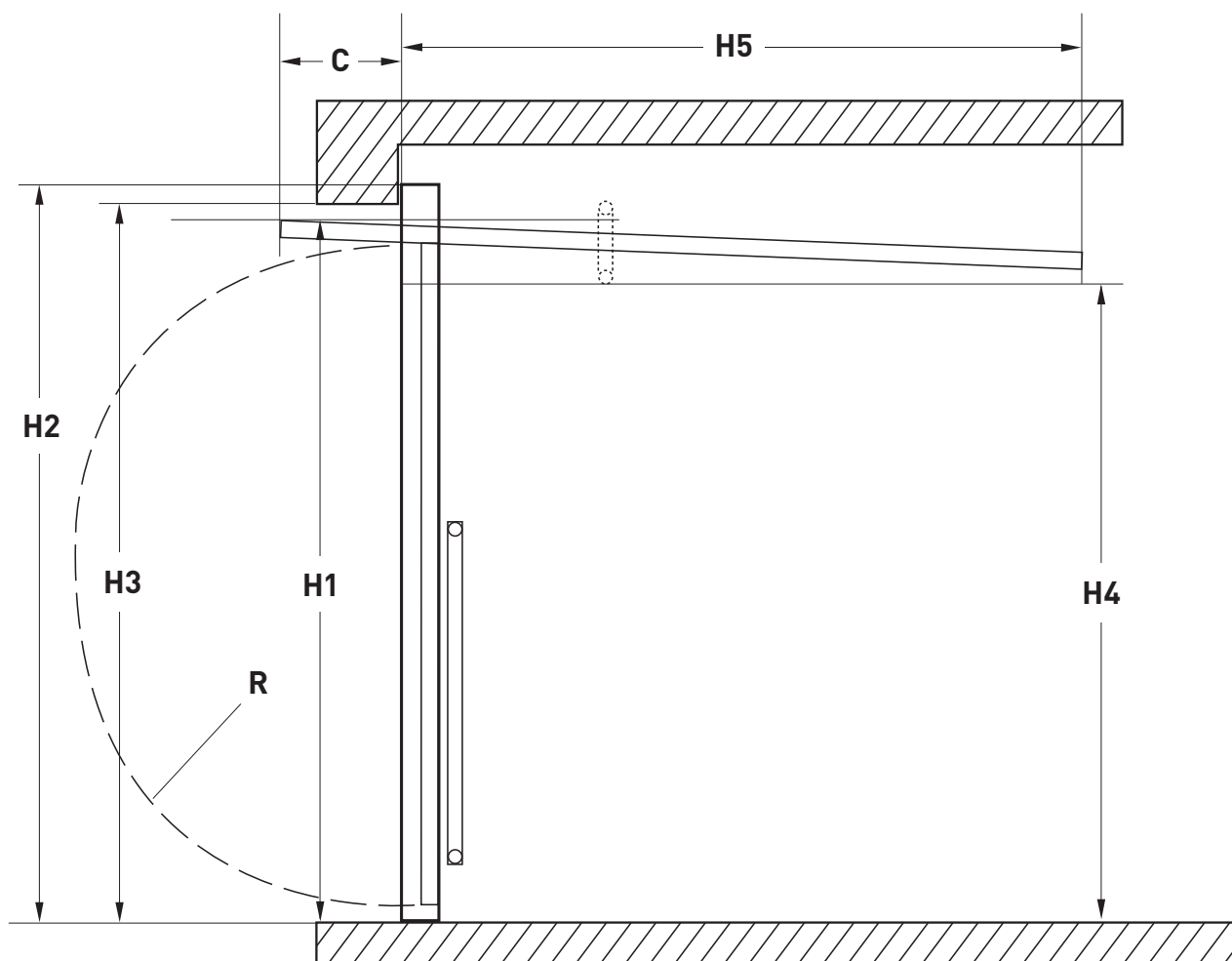

# Technical information

## Double Up & Over Garage Doors. Retractable Gear Type

### Standard Door Widths

Door width		Common dimensions				70mm Wide	
		=W1+24	=W1-	=W1-50	=W1+140		
Imp	Mm	W1	W2	W3A	W3B	W4	W5
8'0"	2438	2438	2462	2318	2388	2578	2588
10'0"	3048	3048	3072	2928	2998	3188	3198
12'0"	3657	3657	3682	3537	3607	3797	3807
14'0"	4267	4267	4291	4147	4217	4407	4417
16'0"	4877	4877	4901	4757	4827	5017	5027

- W1** = Internal Frame Width
- W2** = Minimum Brickwork Opening
- W3A** = Clear Drive through Width - Above the Bottom of the Pivot Arm
- W3B** = Clear Drive through Width - Below the Bottom of the Pivot Arm
- W4** = External Frame Width
- W5** = Recommended Brickwork Opening Width

**NOTE** - The Bottom of the Pivot Arm when the door is open is  
 820mm from the floor on 1981mm high doors  
 970mm from the floor on 2134mm high doors  
 1120mm from the Floor on 2286mm high doors

Frame Leg Dimensions  
 Width = 70mm  
 Depth = 75mm

### Fitting behind the opening

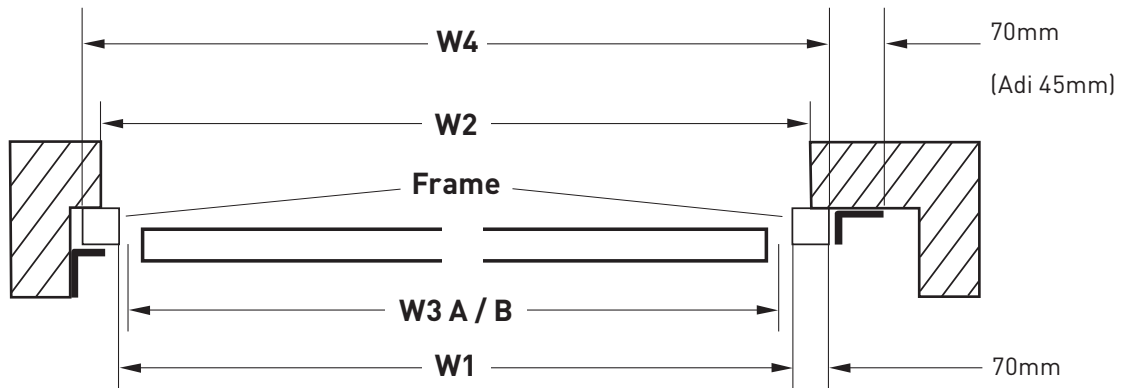

### Fitting within the opening

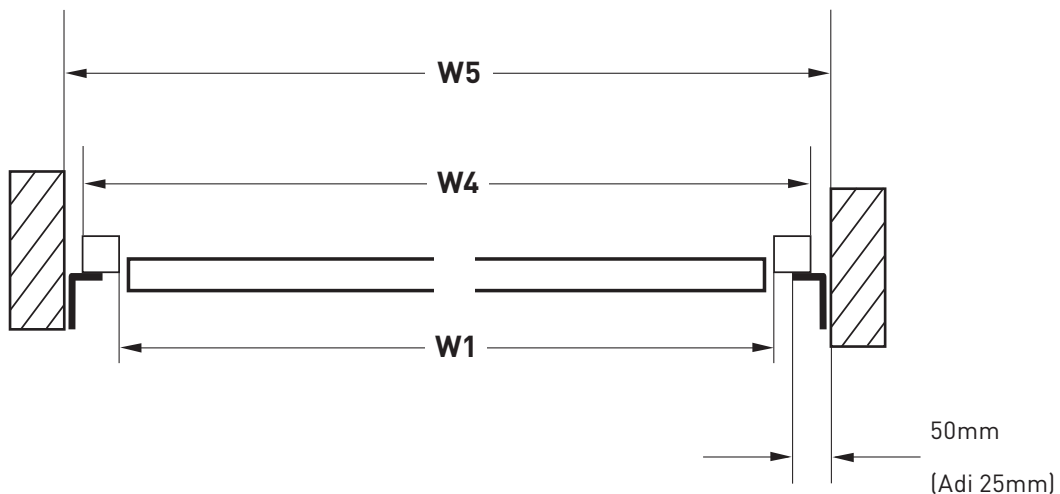

# Technical information

## DuoPort Side Hinge Door Gear Type

### Standard Door Widths

Door width					=W1-
imp	mm	W1	W2	W3	W4
6'6"	1981	1981	2125	2135	1865
7'0"	2134	2134	2278	2288	2018
7'6"	2286	2286	2430	2440	2170
8'0"	2438	2438	2582	2592	2322

**W1** = Internal Frame Width

**W2** = External Frame Width

**W3** = Recommended Brickwork Opening Width – Fitting between the brickwork

**W4** = Clear Drive through Width – Door Open to 90 Degrees

Frame Leg Dimensions – 72mm Wide – 70mm Deep

Order by Brickwork Opening Dimensions or External Frame Size Required

Fitting within the opening

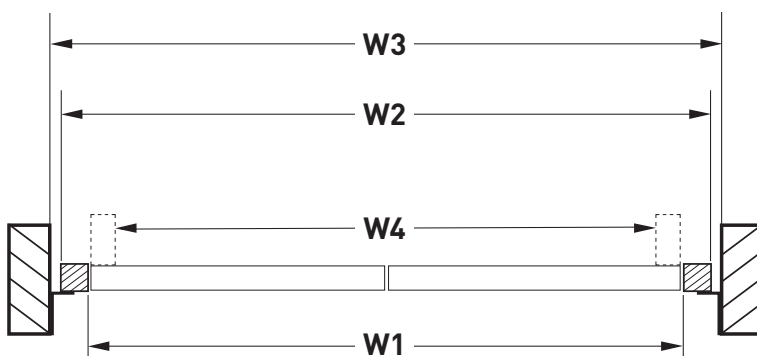

### Standard Door Heights

Door Height			=H1+72	=H1+77	=H1
imp	mm	H1	H2	H3	H4
6'6"	1981	1981	2053	2058	1981
7'0"	2134	2134	2206	2211	2134
7'6"	2286	2286	2358	2363	2286

**H1** = Internal Frame Height

**H2** = External Frame Height

**H3** = Minimum Brickwork Opening Height

**H4** = Clear Drive through Width (Internal Weather Seal is the lowest point)  
[Door stay if fitter are lower locally by 60mm]

Frame Header Dimensions – 72mm High – 70mm Deep

Floor Threshold - 19mm High

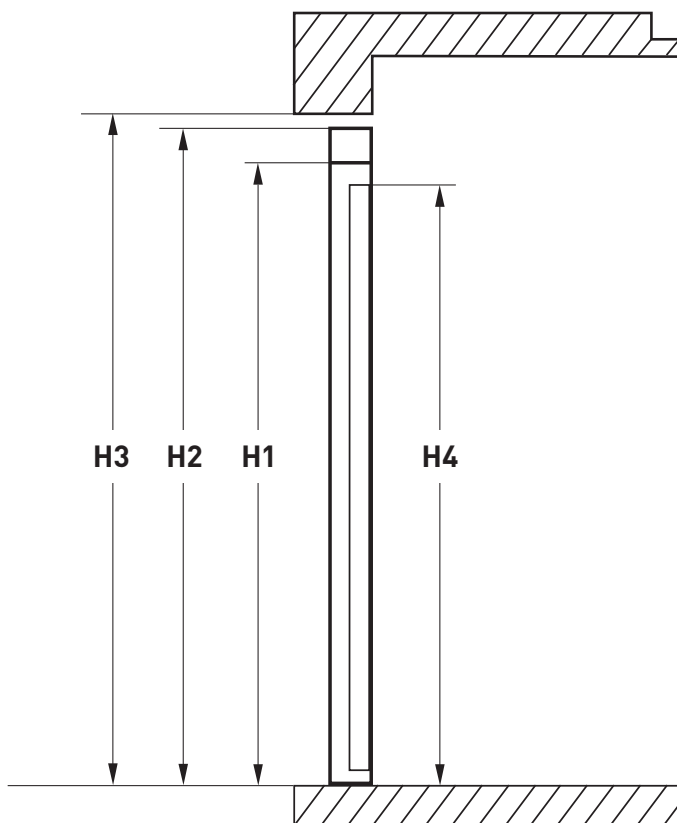

# Technical information

## British Manufactured DuoPort SF Side Hinge Door Gear Type

### Standard Door Widths

Door width					=W1-
imp	mm	W1	W2	W3	W4
6'6"	1981	1981	2081	2091	1881
7'0"	2134	2134	2234	2244	2034
7'6"	2286	2286	2386	2396	2186
8'0"	2438	2438	2538	2548	2338

**W1** = Internal Frame Width

**W2** = External Frame Width

**W3** = Recommended Brickwork Opening Width – Fitting between the brickwork

**W4** = Clear Drive through Width – Door Open to 90 Degrees

Frame Leg Dimensions – 50mm Wide – 63mm Deep

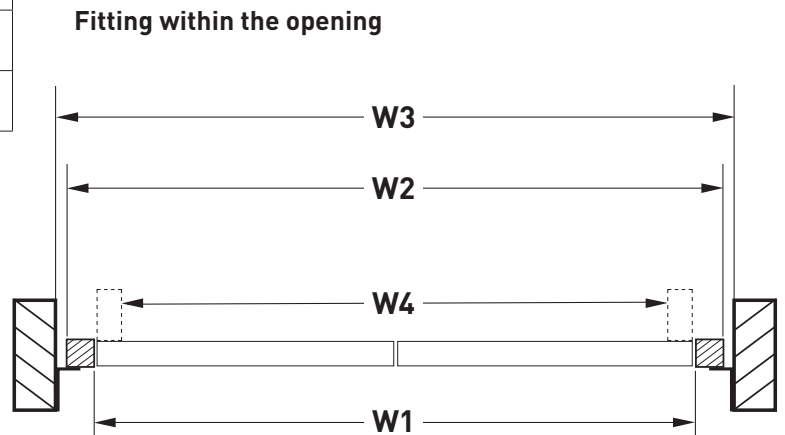

### Standard Door Heights

Door Height			=H1+50	=H1+55	=H1-20
imp	mm	H1	H2	H3	H4
6'6"	1981	1981	2031	2036	1861
7'0"	2134	2134	2184	2189	2114
7'6"	2286	2286	2336	2341	2266

**H1** = Internal Frame Height

**H2** = External Frame Height

**H3** = Minimum Brickwork Opening Height

**H4** = Clear Drive through Width (Internal Weather Seal is the lowest point)  
 (Door stay if fitter are lower locally by 60mm)

Frame Header Dimensions – 50mm High – 63mm Deep

Floor Threshold - 19mm High

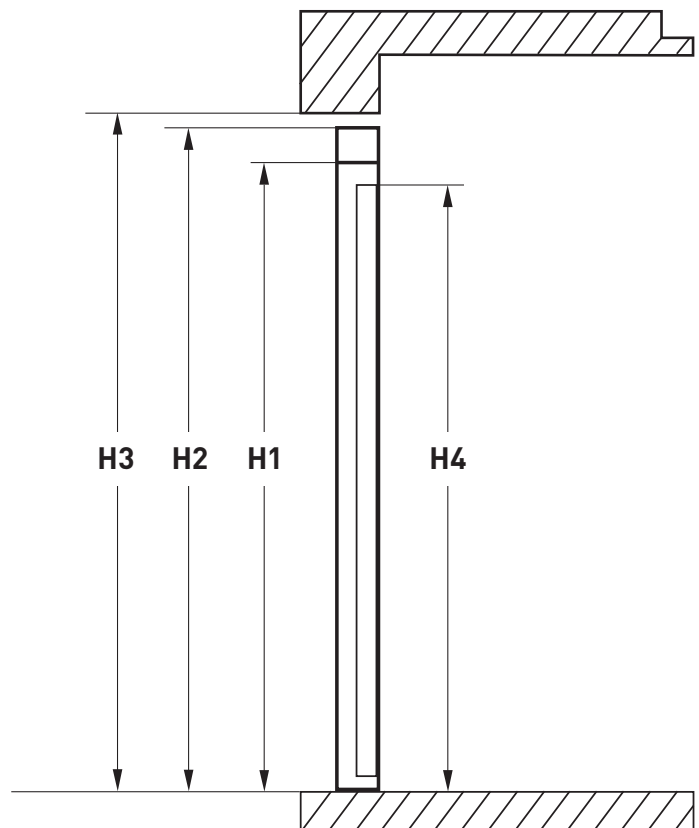

# Technical information

## Insulated Roller Garage Doors

### Fitting within the aperture

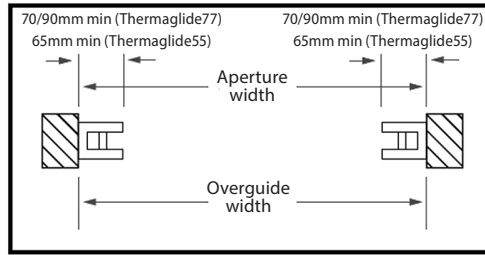
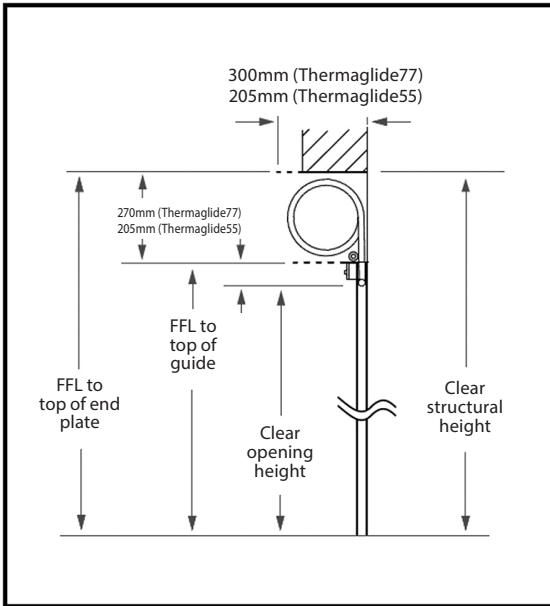

### Fixing options

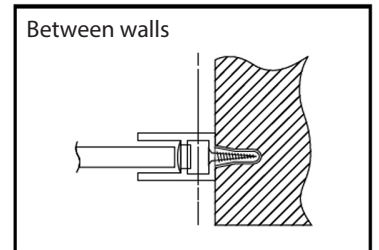
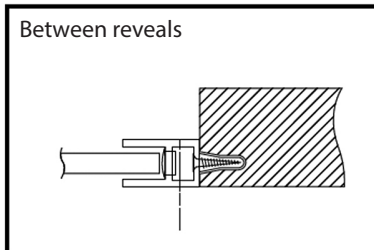

### Fitting onto the aperture

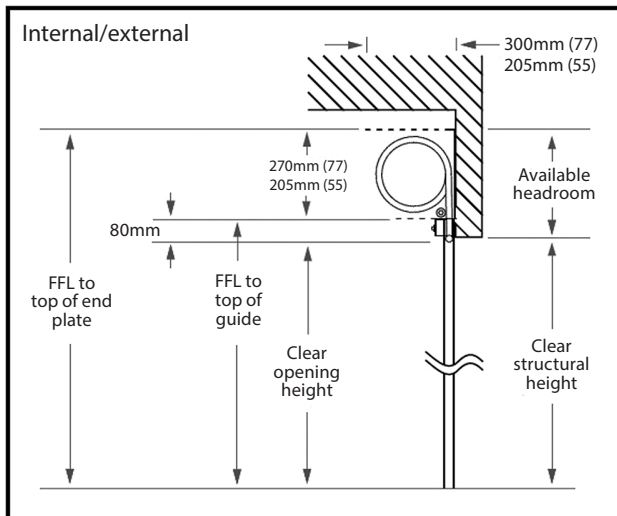

SIDE CLEARANCE: 70/90mm (65mm) is required only if the guides are to be fully concealed. A minimum of 40mm (30mm) is required to give sufficient room for fixing but a portion of the guide tracks (white as standard) will be visible.

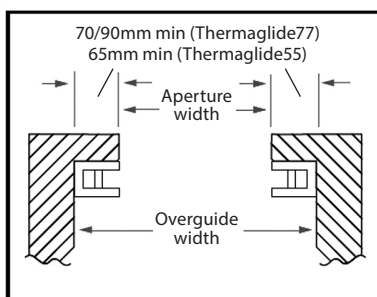

### Fixing options

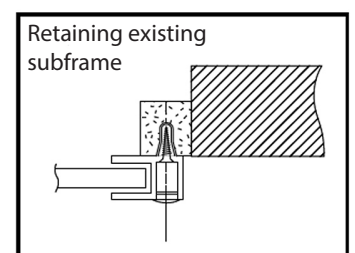
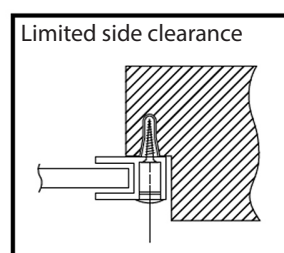
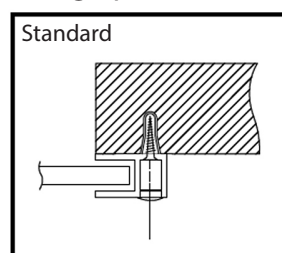

# Technical information

## Steel Line Roller Doors

### Standard & mini steel-line roller doors and brickwork aperture

- Steel-line Roller Doors are specified by brickwork opening size
- There are two sizes of curtain edge guides
- Series "A" 30mm Wide and for brickwork up to 9'6" [2896mm]
- Series "AA" 50mm for Brickwork over 2897mm and Openings over 2438mm High

Steel-line Mini Roller Door –

**MAXIMUM SIZE = 3048 x 2134mm (10'0" X 7'0")**

### Minimum Clearances

Minimum Clearances – Width		
Brickwork Opening Width (BWO)	Curtain Width (mm)	Total Width including fixing brackets "A" = BWO + (2 x 95)mm
1219mm (4'0")	1270	1460
1829mm (6'0")	1880	2070
2134mm (7'0")	2185	2375
2286mm (7'6")	2335	2525
2438mm (8'0")	2488	2678
2591mm (8'6")	2793	2983
2743mm (9'0")	2919	3109
3048mm (10'0")	3148	-
3353mm (11'0")	3453	-
3658mm (12'0")	3758	-
4267mm (14'0")	4367	-
5000mm (16'5")	5100	-

### Notes

- When the door is open the curtain roll extends back into the garage by 500mm for all door heights
- The bottom edge of the curtain is expected to hang down below the lintel by 80mm in normal

Conditions, IE the drive through height will be 80mm less than the aperture height

### Headroom

The minimum Headroom clearance between the bottom of the lintel and the ceiling will vary according to the door height required.

#### For Standard Doors

For Doors up to 2438mm (8'0") High 431mm (17") is required

For Doors from 2438mm (8'0") to 3048mm (10'0") High 483mm (19") is required

#### For Mini Doors

For Doors up to 2134mm (7'0") High 343mm (13 1/2") is required

The Stated headroom for a given height is only required if the door roll is to be hidden from outside view. If the headroom is restricted it is possible to drop the curtain roll by up to 100mm, this will have a corresponding effect on the drive through height.

### Automating the door

When adding an side mounted operator to the curtain an addition amount of side room is required on one side

For a Standard Steel-line Roller door add an additional 30mm to the side room requirement on the side the operator will be fixed

For a Mini Steel-line Roller door add an additional 75mm to the side room requirement on the side the operator will be fixed

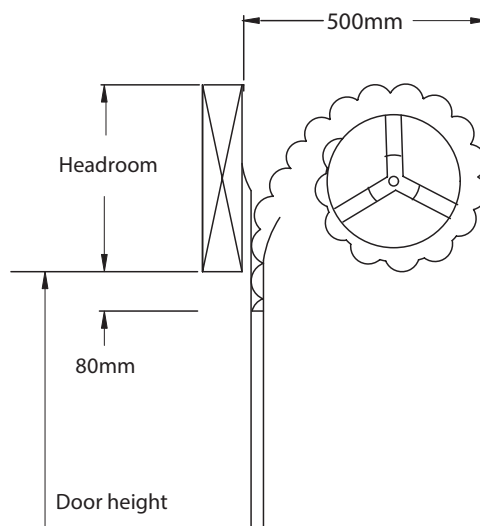
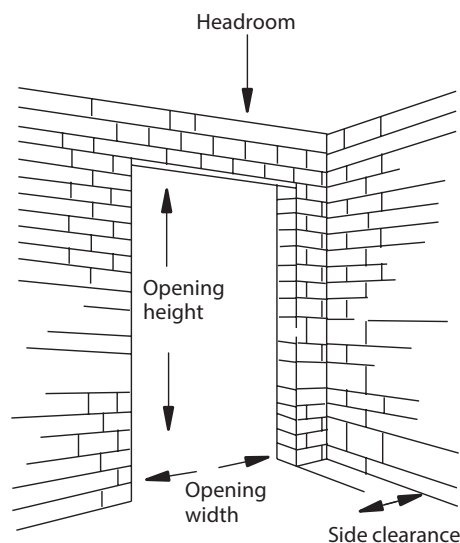

# Terms and conditions

## Warranty Information

The purchaser is granted a warranty covering the safe and reliable functioning of the door. For full warranty details please see our website [www.novoferm.co.uk](http://www.novoferm.co.uk).

## Prices

- All orders are accepted on the understanding that the goods will be subject to the price ruling at the time of delivery, unless other terms are specifically agreed.
- All prices are in £ sterling and exclude VAT. UK mainland delivery is included to the buyer's trading address - delivery to site is possible (subject to access). See delivery details below.
- A 25% handling charge applies to all unwanted items on standard stock items only. Items must be returned unopened and in an unused condition.
- All returns are subject to acceptance by the manufacturer of the garage doors.
- All doors are bespoke and made to order. Your right to cancel is not available on non-standard made to order doors.

## Delivery charges to site

### All doors

Delivery charges per door nett for Mainland England, Scotland and Wales only\*. 1 Door = £58.00. 2 Doors = £96.00. 3 Doors + = free of charge \* Northern Ireland, Channel Islands, Isle of Man, and export delivery – please contact our customer services for further details. \*Additional charges may be applied to remote rural locations - please contact our customer services for further details. Carriage charges and VAT to be added to all prices.

## Specification

- Due to the progressive outlook of the manufacturer we reserve the right to alter specifications to design and manufacture without notification.
- All specifications and details are correct at the time of publication, errors and omissions excepted.

Your Cardale Stockist

09/20. Cardale reserves the right to alter specifications to design and manufacture without notification. All specifications are correct at time of publication, errors and omissions excepted.

Cardale Garage Doors  
Unit 5-9 Luton North Industrial Estate, Sedgwick Road, Luton LU4 9DT  
t: 01582 563777 f: 01582 568801  
[www.cardale.co.uk](http://www.cardale.co.uk)  
Opening times: Mon-Fri 8.30am - 5.00pm

## All Doors

### Colour Match

- Pairs of doors should be ordered together to obtain the best colour match, bearing in mind the limitations of the materials used in the construction.
- Dark colours on garage doors which are exposed to direct sunlight for a considerable period of time should be avoided as they will fade more noticeably due to the strong sunlight
- All colour samples depicted in this brochure are as close to the original manufacturer's colours as possible. Garage doors supplied may vary in colour from the brochure representation due to printing processes.

### Timber Garage Doors

- Since wood is a natural product any finish may vary due to the natural nature of the wood grain so we **cannot guarantee** an exact match when ordering a matching set.

### Size Variations

- As the size of a door changes in height and/or width, the panel frequency and profile can change, therefore doors of the same style but of different sizes can display a significant difference in appearance.

### Clearances

- All doors require operating clearances, i.e. the gap between the door panel and frame opening, these are inbuilt during manufacture and should not be reduced by means of infills, or draught proofing.

### Deflection

- When in the open position, all doors will display a level of vertical deflection or 'sag' across the width of the panel.
- Individual manufacturers' specifications should be consulted for exact tolerances.

### Care and Maintenance

- In order to get the best from your door, and for your door to be fully covered by the Guarantee, there are some things you will need to do throughout the guarantee cover period and throughout the life of the door in order to maintain and care for your garage door. Please see our website for full details on how to do this [www.novoferm.co.uk](http://www.novoferm.co.uk)

